

MOBILIÁRIO ESCOLAR | MOBILIER SCOLAIRE

SCHOOL FURNITURE







THE SCHOOL

EN

COMPANY

Since 1978 Industrial Laborum Ibérica is the first Portuguese company to produce and install laboratory furniture, taking advantage of a growing market segment that until now were solely dependent on imports of goods and services of foreign companies.

SCHOOL

The school is a living, evolving and heterogeneous system, either by requiring the combination of different functional areas or by the morphological conditions, as well as the architectural and constructive quality of the building itself. The need to equip schools with new resources in order to provide an appropriate working environment to the practice of a modern education has enabled Industrial Laborum Ibérica, based on its extensive experience in hospitals and laboratories, to develop school projects.

Projects based on principles of durability and sustainability, which include standardized solutions, arise from the implementation of standard projects and serial construction, but also innovative solutions, in terms of space and construction, in buildings with recognized heritage value.

Hence, Industrial Laborum Ibérica meets the requirements of the new educational and environmental paradigms ensuring the conditions for schools' integrated work.

Quality Standards and Certification

Industrial Laborum Ibérica is annually audited and certified by TÜV Rheinland Group, a multinational, leader in providing inspection and certification.

Therefore, ILI's lab furniture accomplish the most demanding regulations, because the whole manufacturing process is certified according ISO 9001:2008.

The investment in recognition of our expertise includes the testing and certification of Fume Cupboards, EN14175-2:2003 (Ed.1) e EN14175-3:2003 (Ed.1) and Chemical Laboratory Benches, EN 13150:2002 (Ed.1).

PT

EMPRESA

Desde 1978 a Industrial Laborum Ibérica é a primeira empresa portuguesa a produzir e instalar mobiliário de laboratório, aproveitando um segmento de mercado em ascensão que, até à data, dependia exclusivamente da importação de bens e serviços de empresas estrangeiras.

ESCOLA

A escola é um organismo vivo, evolutivo e um conjunto heterogéneo quer pela exigência da articulação dos seus diferentes sectores funcionais quer pelas condições tipo-morfológicas e qualidade arquitectónica e construtiva do próprio edifício onde se insere. A necessidade de dotar as escolas de novos meios que proporcionem ambientes de trabalho adequados à prática de um ensino moderno permitiu à Industrial Laborum Ibérica, com base na sua vasta experiência nas áreas hospitalar e laboratorial, o desenvolvimento de projectos para escolas.

Projectos assentes em princípios de durabilidade e sustentabilidade de intervenção, que compreendem soluções normalizadas, decorrentes da aplicação de projectos-tipo e recorrentes à construção em série, mas também soluções inovadoras, em termos espaciais e construtivos, em edifícios com reconhecido valor patrimonial.

A Industrial Laborum Ibérica responde, deste modo, às exigências decorrentes dos novos paradigmas educativos e ambientais, garantindo as condições para o funcionamento integrado das escolas.

Normas e Certificação

A Industrial Laborum Ibérica é anualmente auditada e certificada pela TÜV Rheinland Group, empresa líder na prestação de serviços de inspecção e certificação. Assim, o mobiliário de laboratório da ILI cumpre os regulamentos mais exigentes, já que todo o processo de produção tem a certificação ISO 9001:2008.

A aposta no reconhecimento das nossas competências abrange, ainda, o ensaio e a certificação das Hottes Químicas, EN14175-2:2003 (Ed.1) e EN14175-3:2003 (Ed.1) e das Bancadas Laboratoriais, EN13150:2001 (Ed.1).

FR

ENTREPRISE

Depuis 1978 Industrial Laborum Ibérica est la première entreprise portugaise à produire et installer du mobilier de laboratoire, bénéficiant ainsi d'un segment en ascension dans le marché, qui à date dépendait exclusivement de l'importation des biens et services de compagnies étrangères.

L'ÉCOLE

L'école est un organisme vif et en évolution constante, c'est un ensemble hétérogène dû aux exigences d'articulation de ses différents secteurs fonctionnelles et par les conditions type morphologiques et qualités architecturales et constructives des propres bâtiments ou se développe. La nécessité de fournir les écoles de nouveaux moyens qui proportionnent des environnements de travail adéquats à la pratique de l'enseignement moderne à permit à Industrial laborum Ibérica, basé sur sa vaste expérience dans les domaines hospitaliers et de laboratoire, de développer des projets pour les établissements d'enseignement.

Ces projets sont basés sur des principes de durabilité et d'intervention soutenable, qui englobe des solutions normalisées, basés sur des projets types et sur la construction en série, mais également innovatrices, en ce qui concerne l'espace et la construction, sur des édifices avec valeur patrimoniale.

Industrial Laborum Ibérica répond, de cette façon, aux exigences des nouveaux paradigmes d'enseignement et des conditions environnementales pour assurer le fonctionnement intégré des écoles.

Normes et Spécifications

Industrial laborum Ibérica est annuellement contrôlée et certifié par la TÜV Rheinland Group, société leader dans la prestation de services d'inspection et certification. Ainsi le mobilier de laboratoire de ILI répond aux règlements les plus exigeants, vu que tout le processus de production à une certification ISO 9001:2008.

Le parie sur la reconnaissance de nos compétences s'étend aussi à la recherche et certification des Sorbonnes de chimie, EN 14175-2 :2003 (Ed. 1) et EN 14175-3 :2003 (Ed. 1) et des paillasse de laboratoires, EN 13150 :2011 (Ed. 1).



LAB'S SPATIAL LAYOUT + STANDARD PREP. ROOM

EN

SCHOOL STANDARD CLASSROOMS

The projects which include standardized solutions have generally two standard classrooms: the lab and preparation room.

Through a plan and two views of the same simulated space, it is possible to understand the layout of the fixed and non-fixed equipments throughout the space, as well as the type of equipment of each classroom.

PT

SALAS TIPO DA ESCOLA

The projects which include standardized solutions have generally two standard classrooms: the lab and preparation room.

Through a plan and two views of the same simulated space, it is possible to understand the layout of the fixed and non-fixed equipments throughout the space, as well as the type of equipment of each classroom.

FR

SALLES TYPE DE L'ÉCOLE

Les projets qui englobe des solutions normalisées ont généralement deux types de salles standard: le laboratoire et la salle de préparation.

Grâce à un plan et deux vues d'un même espace simulé, on comprend comment le matériel non-fixe et fixe peut éventuellement s'organiser dans l'espace et l'équipement de chaque salle.

VIEWPORT 1 | VISTA 1 | VUE 1

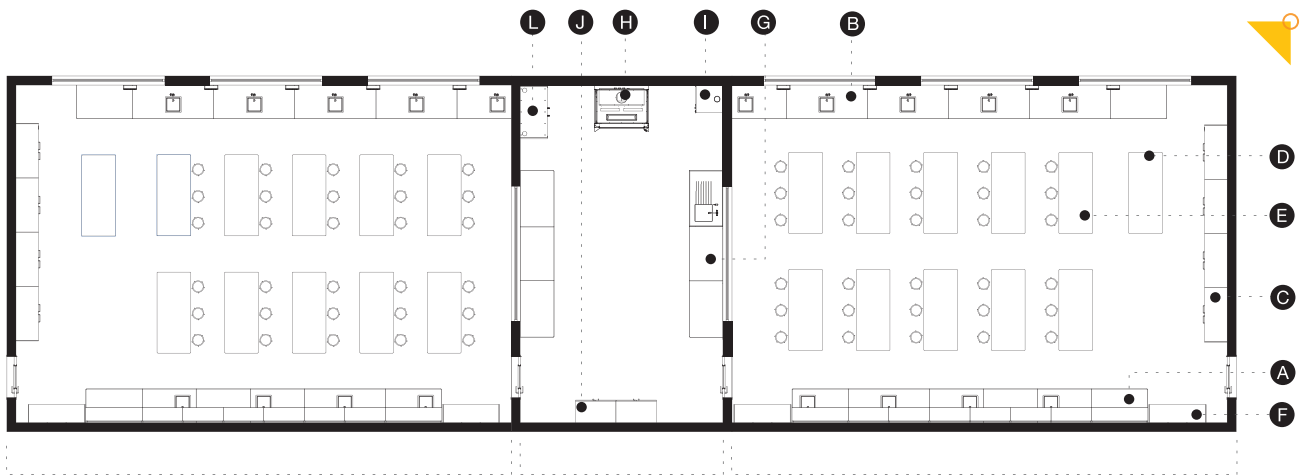

VIEWPORT 2 | VISTA 2 | VUE 2

CLASSROOM - LABORATORY

SALA DE AULA - LABORATÓRIO
SALE DE CLASSE - LABORATOIRE

PREPARATION ROOM

SALA DE PREPARAÇÃO
SALE DE PRÉPARATION

CLASSROOM - LABORATORY

SALA DE AULA - LABORATÓRIO
SALE DE CLASSE - LABORATOIRE

CLASSROOM - LABORATORY
SALA DE AULA - LABORATÓRIO
SALE DE CLASSE - LABORATOIRE

PREPARATION ROOM
SALA DE PREPARAÇÃO
SALE DE PRÉPARATION

- A** WALL BENCH WITH SHELVING MODULES | BANCADA MURAL COM ALÇADO | PAILLASSE MURALE AVEC ÉTAGÈRE
- B** WALL BENCH WITHOUT SHELVING MODULES | BANCADA MURAL SEM ALÇADO | PAILLASSE MURALE SANS ÉTAGÈRE
- C** INSTRUCTION WALL | PAREDE DE ENSINO | MUR D'ENSEIGNEMENT
- D** TEACHER TABLE | MESA PROFESSORES | PAILLASSE DE PROFESSEUR
- E** STUDENT TABLE | MESA ALUNOS | PAILLASSE D'ÉLÈVE
- F** STORAGE COMBS | FAVOS DE ARRUMAÇÃO | UNITÉ DE STOCKAGE
- G** PREP. ROOM BENCHES | BANCADA DE SALAS DE PREPARAÇÃO | PAILLASSE POUR SALE DE PRÉPARATION
- H** FUME CUPBOARD | HOTTE | SORBONNE
- I** CABINET FOR CORROSIVE SUBSTANCES | ARMÁRIO PARA SUBSTÂNCIAS CORROSIVAS | ARMOIRE POUR SUBSTANCES CORROSIVES
- J** TALL CABINET | ARMÁRIO ESTANTE | ARMOIRE ÉTAGÈRE
- L** CABINET FOR FLAMMABLE PRODUCTS | ARMÁRIO DE PRODUTOS INFLAMÁVEIS | ARMOIRE POUR PRODUITS INFLAMMABLES

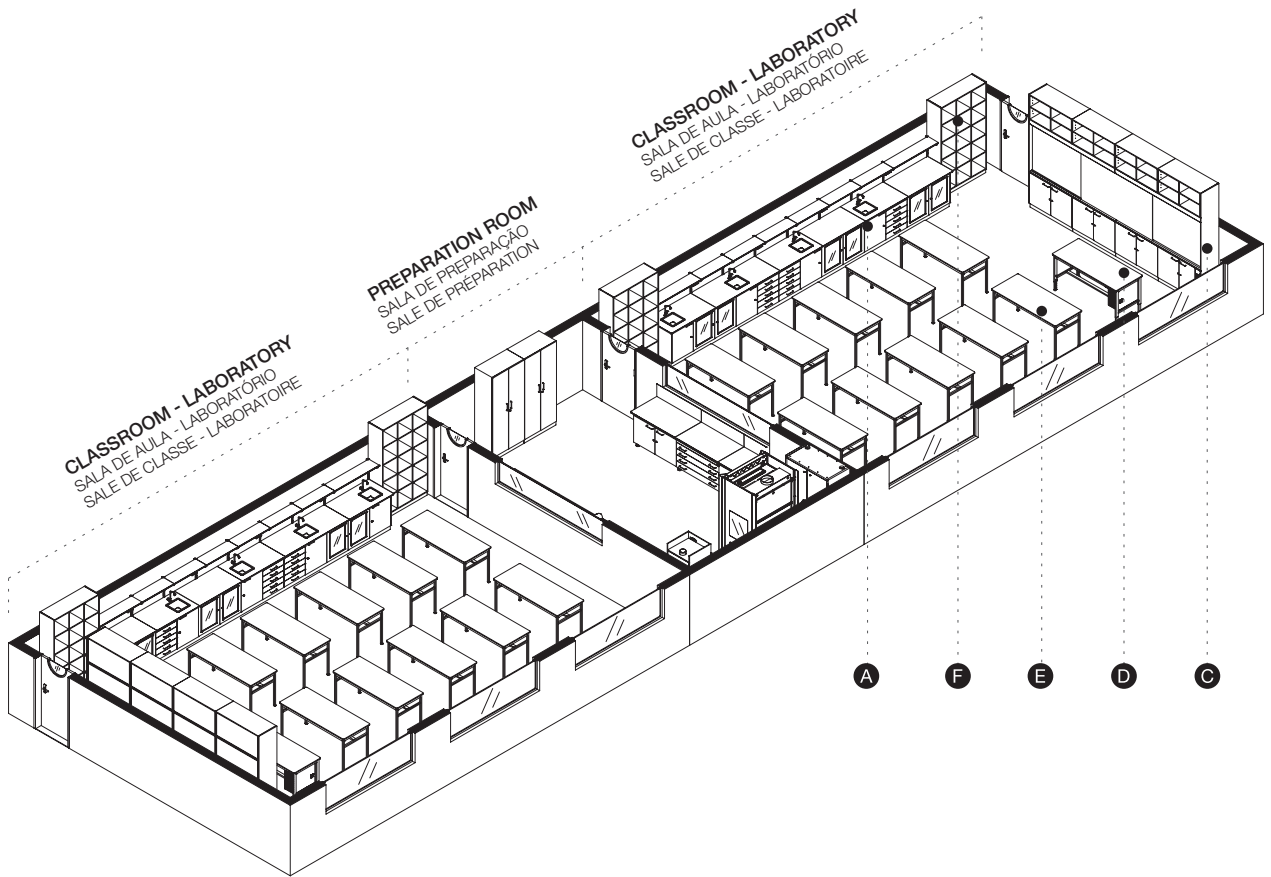

VIEWPORT 1 | VISTA 1 | VUE 1

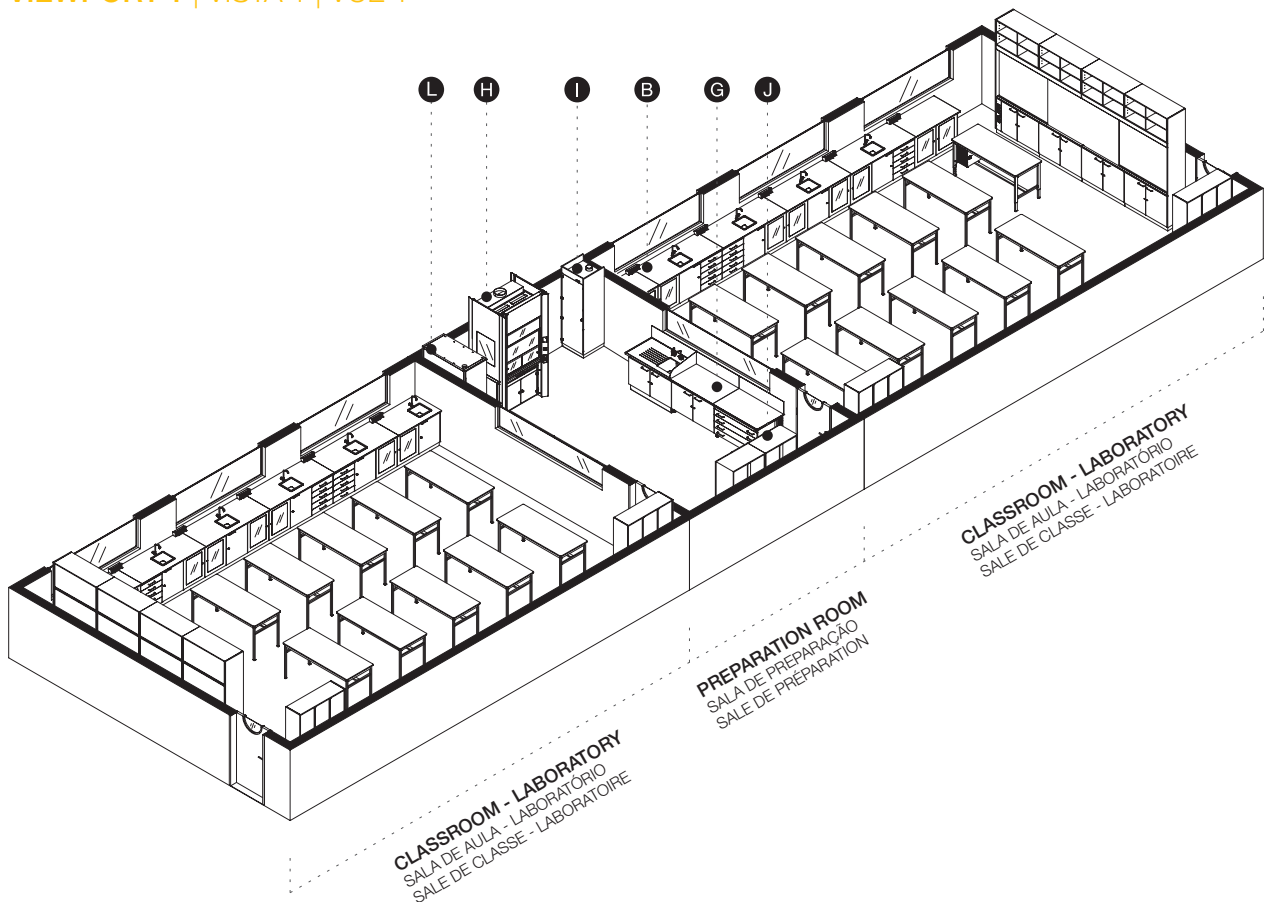

VIEWPORT 2 | VISTA 2 | VUE 2

















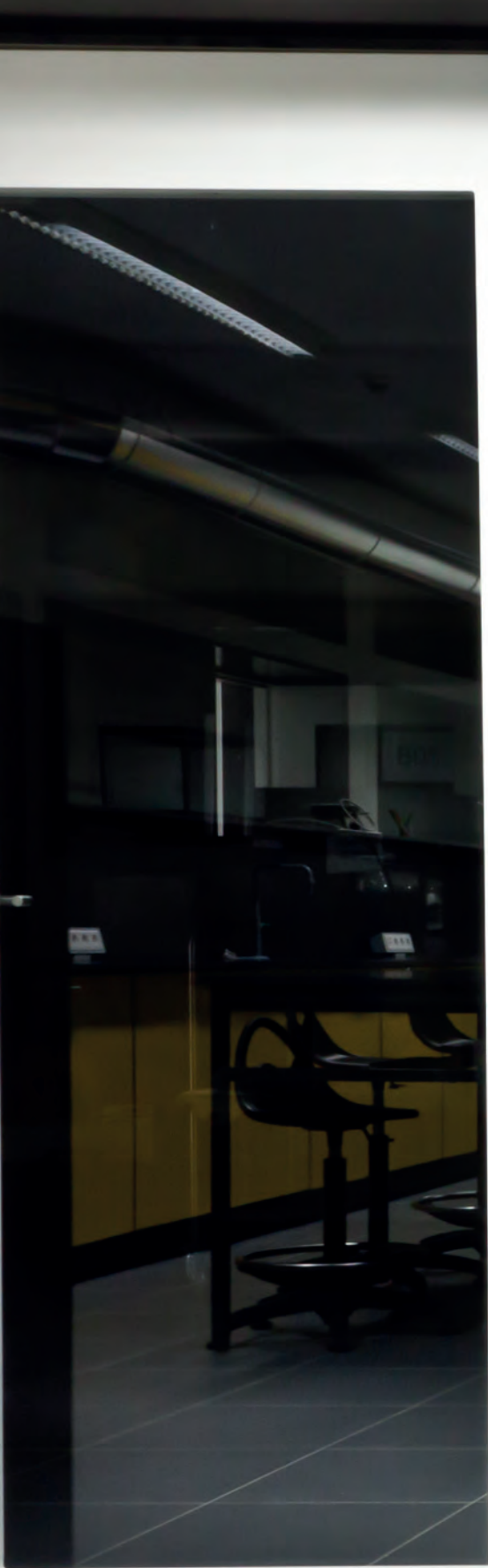

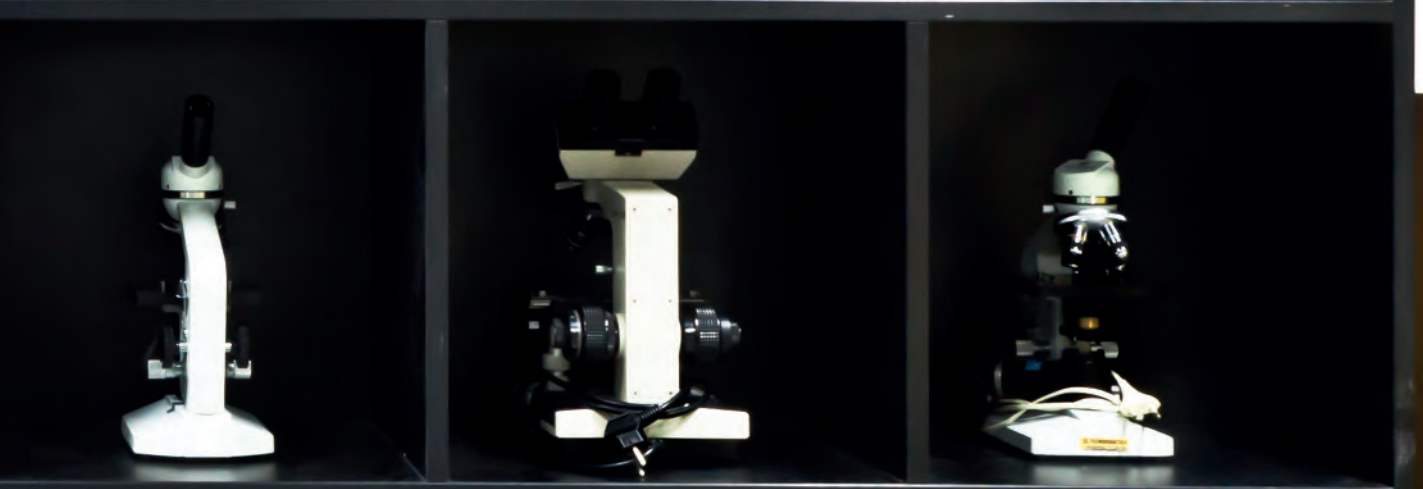
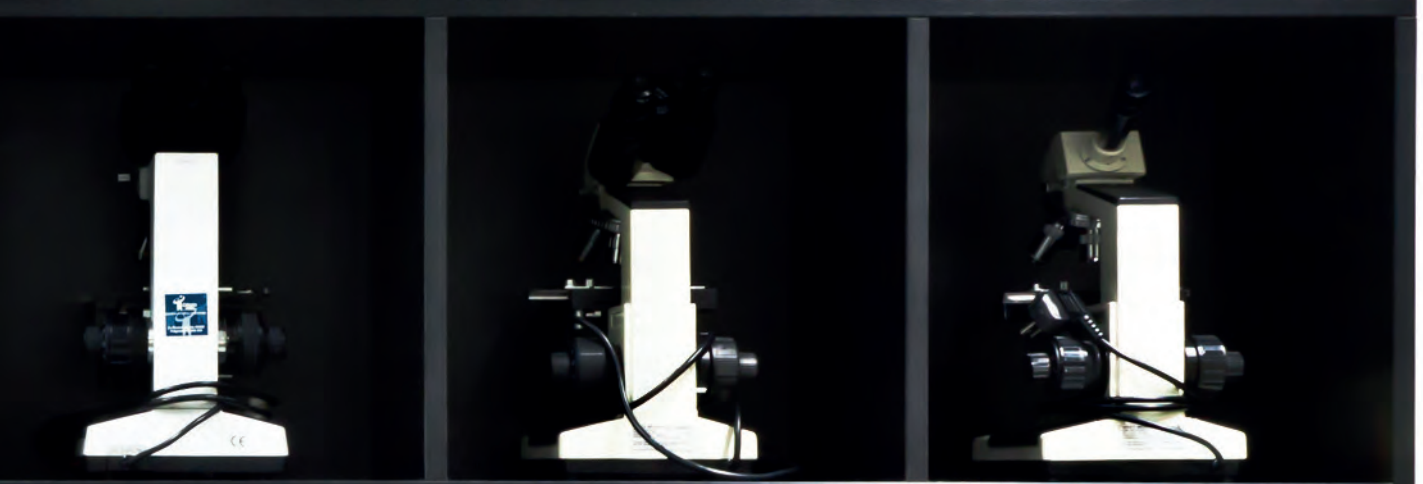

















PRIORIT
INDUSTRIAL LABORUM IBERICA
C/ ALFONSO X EL MAGNO, 10
46100 BURJASSOT (VALENCIA)
TEL: 96 351 11 11
WWW.PRIORIT.COM

30

CE









BANCADA MURAL ESCOLAR
COM ALÇADO |
PAILLASSE MURALE SCOLAIRE
AVEC ÉTAGÈRES

SCHOOL BENCH WITH SHELVES

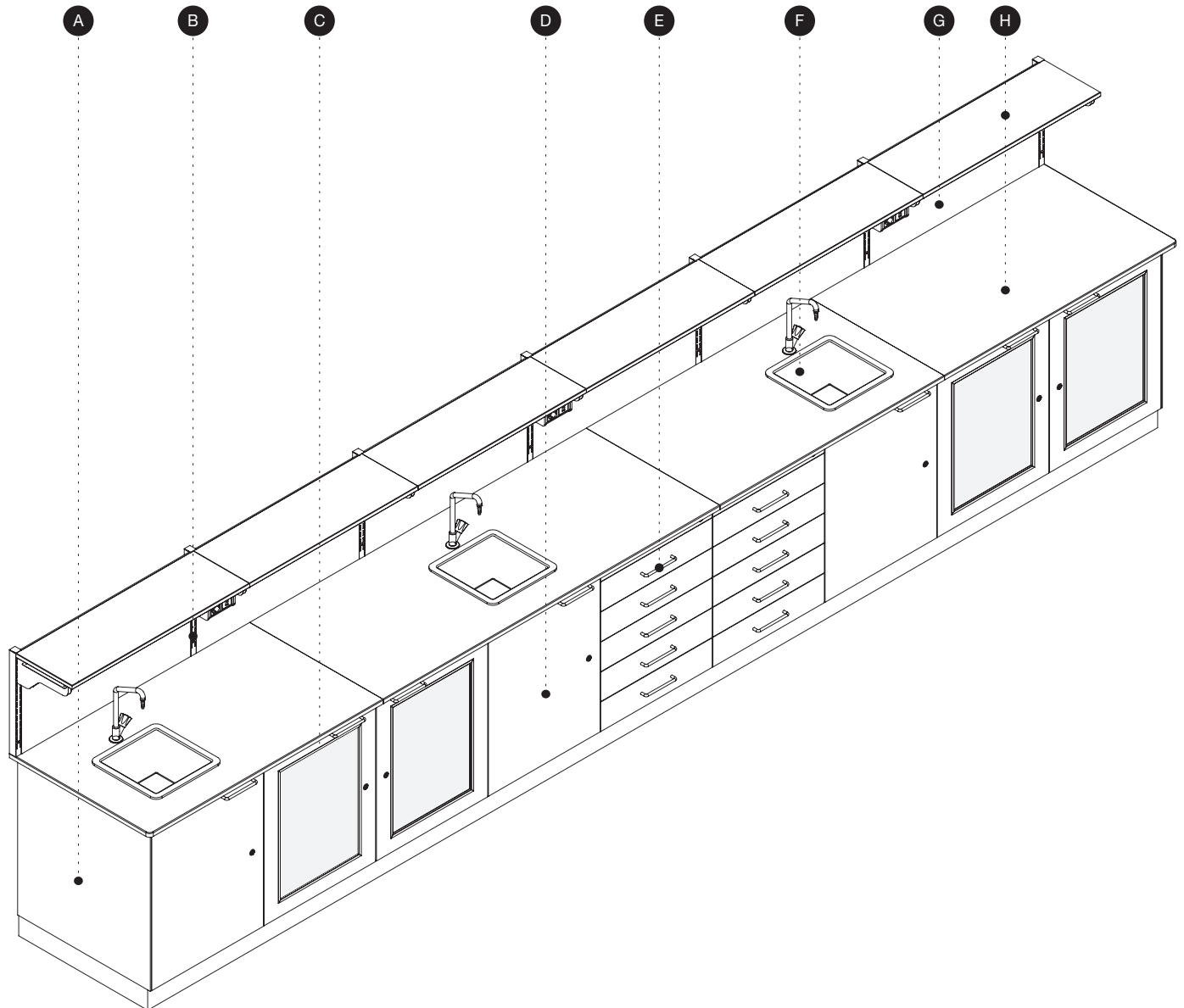
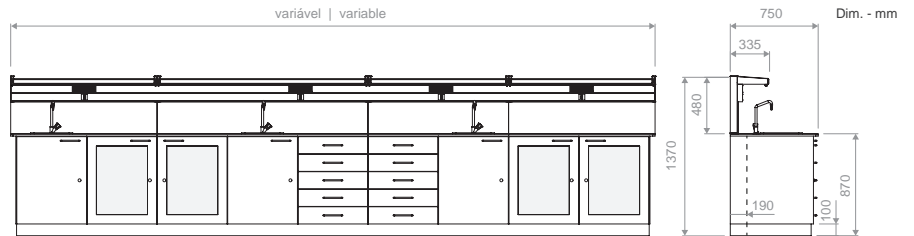

A

CARCASES | CORPOS | CORPS

MATERIAL: MELAMINE
MATERIAL: MELAMINA
MATÉRIEL: MÉLAMINE

STANDARD

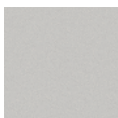

GRAY
CINZA
GRIS
U 708 - ST15

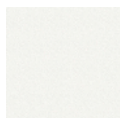

WHITE
BRANCO
BLANC
W 980 - ST2

OPTIONAL
OPCIONAL | OPTIONNEL



BLACK
PRETO
NOIR
U 999 - ST2

B

STRUCTURE | ESTRUTURA | STRUCTURE

MATERIAL: METAL
MATERIAL: METAL
MATÉRIEL: METAL

STANDARD



ANTHRACITE
ANTRACITE
ANTHRACITE
RAL 7026



GRAY
CINZA
GRIS
RAL 7035



WHITE
BRANCO
BLANC
RAL 9010

OPTIONAL
OPCIONAL | OPTIONNEL



BLACK
PRETO
NOIR
RAL 9005

C**TRANSPARENT FRONTS** | FRENTE
TRANSPARENTES | FAÇADES TRANSPARENTES**MATERIAL: ACRYLIC CRYSTAL**
MATERIAL: ACRÍLICO CRISTAL
MATÉRIEL: CRISTAL ACRYLIQUE

STANDARD

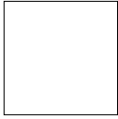
**TRANSPARENT**
TRANSPARENTE
TRANSPARENT**E****HANDLE** | PUXADOR | POIGNÉE**MATERIAL: STAINLESS STEEL**
MATERIAL: AÇO INOX
MATÉRIEL: ACIER INOXYDABLE

STANDARD

**STAINLESS STEEL**
AÇO INOX
ACIER INOXYDABLE**F****SINK** | PIO | ÉVIER**MATERIAL: POLYPROPYLENE**
MATERIAL: POLIPROPILENO
MATÉRIEL: POLYPROPYLÈNE

STANDARD

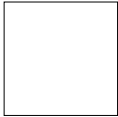
**WHITE**
BRANCO
BLANC**G****PANELS** | PAINÉIS | PANNEAUX**MATERIAL: PHENOLIC COMPACT**
MATERIAL: COMPACTO DE RESINAS FENÓLICAS
MATÉRIEL: COMPACTE DE RÉSINES PHÉNOLIQUES

STANDARD

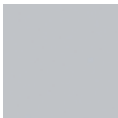
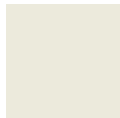
**GRAY**
CINZA
GRIS**WHITE**
BRANCO
BLANCOPTIONAL
OPCIONAL | OPTIONNEL**BLACK**
PRETO
NOIR

EN

NOTESOptional - colors on request
fronts - edges are the same color of carcasses

PT

NOTASOpcional - cores sob consulta
frentes- orla da mesma cor dos corpos

FR

NOTEOptionnel - couleurs sous demande
chants de la même couleurs que les corps**D****OPAQUE FRONTS** | FRENTE
OPACAS | FAÇADES OPAQUE**MATERIAL: MELAMINE**
MATERIAL: MELAMINA
MATÉRIEL: MÉLAMINE

STANDARD

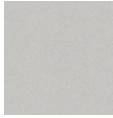
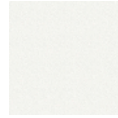
**GRAY**
CINZA
GRIS
U 708 - ST15**WHITE**
BRANCO
BLANC
W 980 - ST2OPTIONAL
OPCIONAL | OPTIONNEL

U 104 - ST15



U 114 - ST15



U 143 - ST15



U 332 - ST15



U 518 - ST9

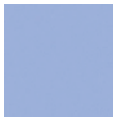

U 522 - ST15



U 525 - ST15



U 536 - ST15



U 625 - ST15



U 632 - ST15



U 999 - ST2

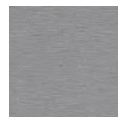

F 501 - ST2

H**WORKTOP + SHELVES** | TAMPO + PRATELEIRAS |
PLAN DE TRABALHO + ÉTAGÈRES**MATERIAL: TRESPA TOPLAB PLUS**
MATERIAL: TRESPA TOPLAB PLUS
MATÉRIEL: TRESPA TOPLAB PLUS

STANDARD

**GRAY**
CINZA
GRIS
T 03.4.0**WHITE**
BRANCO
BLANC
T 03.0.0OPTIONAL
OPCIONAL | OPTIONNEL**BLACK**
PRETO
NOIR
T 90.0

BANCADA MURAL ESCOLAR
SEM ALÇADO |
PAILLASSE MURALE SCOLAIRE SANS
ÉTAGERES

SCHOOL BENCH WITHOUT SHELVES

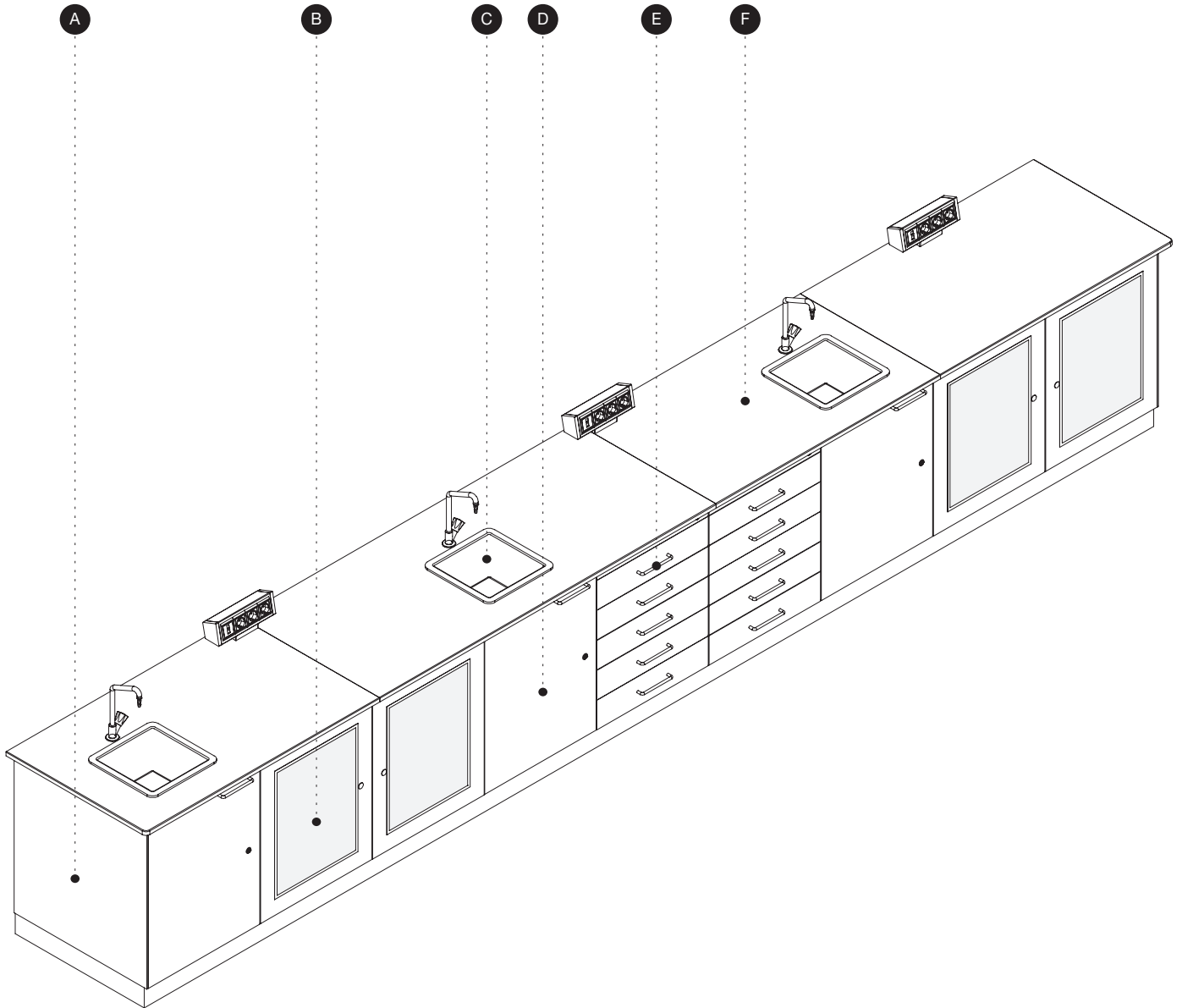
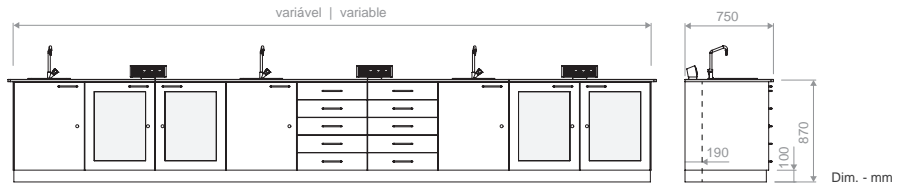

A

CARCASES | CORPOS | CORPS

MATERIAL: MELAMINE
MATERIAL: MELAMINA
MATÉRIEL: MÉLAMINE

STANDARD



GRAY
CINZA
GRIS
U 708 - ST15

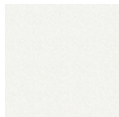

WHITE
BRANCO
BLANC
W 980 - ST2

OPTIONAL
OPCIONAL | OPTIONNEL



BLACK
PRETO
NOIR
U 999 - ST2

B

TRANSPARENT FRONTS | FRENTES TRANSPARENTES | FAÇADES TRANSPARENTES

MATERIAL: ACRYLIC CRYSTAL
MATERIAL: ACRÍLICO CRISTAL
MATÉRIEL: CRISTAL ACRYLIQUE

STANDARD



TRANSPARENT
TRANSPARENT
TRANSPARENT

C**SINK | PIO | ÉVIER****MATERIAL: POLYPROPYLENE**MATERIAL: POLIPROPILENO
MATÉRIEL: POLYPROPYLÈNE

STANDARD

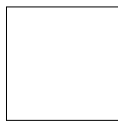
**WHITE**
BRANCO
BLANC**D****OPAQUE FRONTS | FRENTES OPACAS |
FAÇADES OPAQUE****MATERIAL: MELAMINE**MATERIAL: MELAMINA
MATÉRIEL: MÉLAMINE

STANDARD

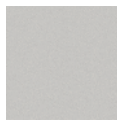
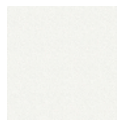
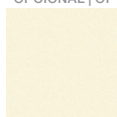
**GRAY**
CINZA
GRIS
U 708 - ST15**WHITE**
BRANCO
BLANC
W 980 - ST2OPTIONAL
OPCIONAL | OPTIONNEL

U 104 - ST15



U 114 - ST15



U 143 - ST15



U 332 - ST15



U 518 - ST9

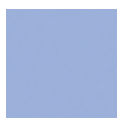

U 522 - ST15



U 525 - ST15



U 536 - ST15



U 625 - ST15



U 632 - ST15



U 999 - ST2



F 501 - ST2

E**HANDLE | PUXADOR | POIGNÉE****MATERIAL: STAINLESS STEEL**MATERIAL: AÇO INOX
MATÉRIEL: ACIER INOXYDABLE

STANDARD

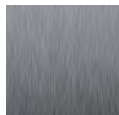
**STAINLESS STEEL**
AÇO INOX
ACIER INOXYDABLE**F****WORKTOP + SHELVES | TAMPO + PRATELEIRAS |****PLAN DE TRAVAIL + ÉTAGÈRES****MATERIAL: TRESPA TOPLAB PLUS**MATERIAL: TRESPA TOPLAB PLUS
MATÉRIEL: TRESPA TOPLAB PLUS

STANDARD

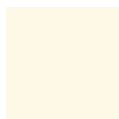
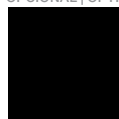
**GRAY**
CINZA
GRIS
T 03.4.0**WHITE**
BRANCO
BLANC
T 03.0.0OPTIONAL
OPCIONAL | OPTIONNEL**BLACK**
PRETO
NOIR
T 90.0

EN

NOTESOptional - colors on request
fronts - edges are the same color of carcases

PT

NOTASOpcional - cores sob consulta
frentes- orla da mesma cor dos corpos

FR

NOTEOptionnel - couleurs sous demande
chants de la même couleurs que les corps

PAREDE DE ENSINO |
MUR D'ENSEIGNEMENT

INSTRUCTION WALL

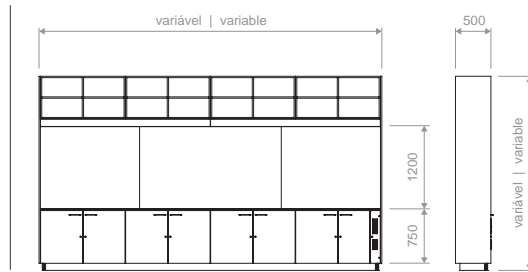

Dim. - mm

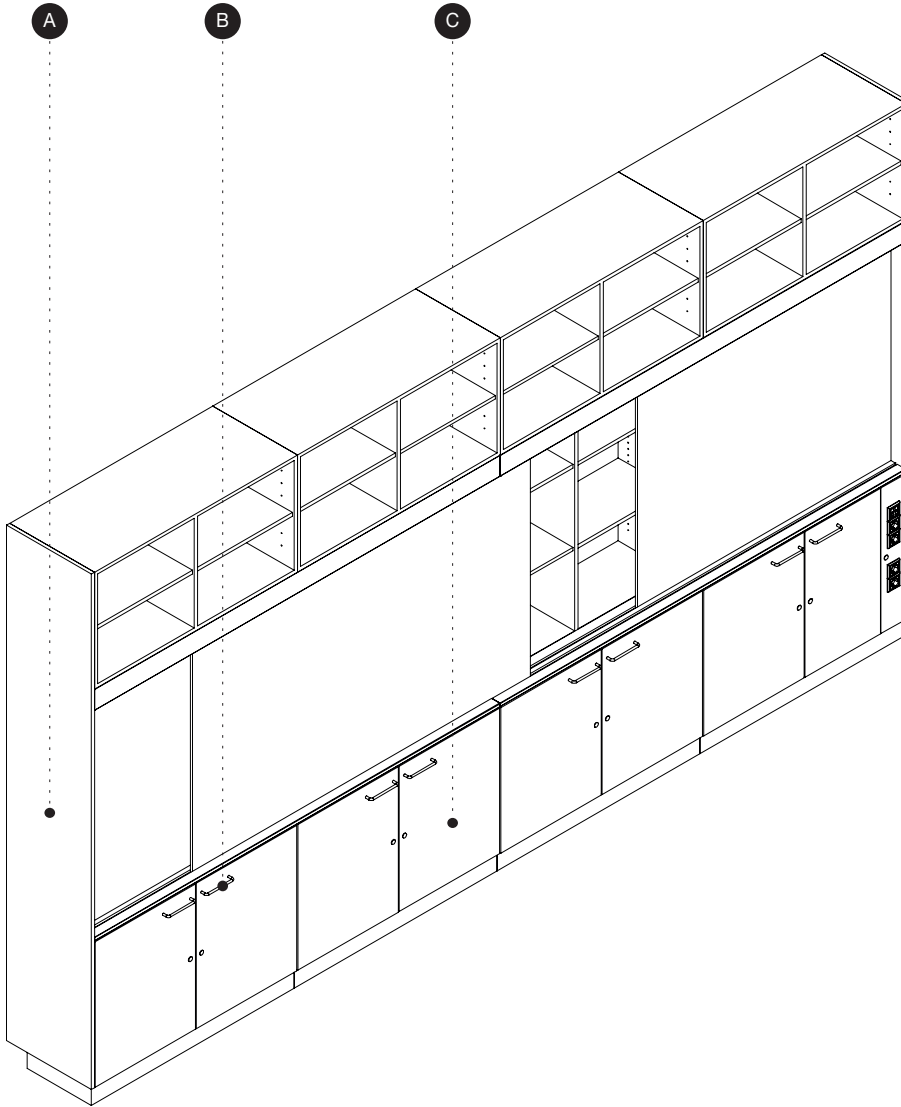

A

CARCASES | CORPOS | CORPS

MATERIAL: MELAMINE
MATERIAL: MELAMINA
MATÉRIEL: MÉLAMINE

STANDARD



GRAY
CINZA
GRIS
U 708 - ST15

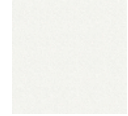

WHITE
BRANCO
BLANC
W 980 - ST2

OPTIONAL
OPCIONAL | OPTIONNEL



BLACK
PRETO
NOIR
U 999 - ST2

B

HANDLE | PUXADOR | POIGNÉE

MATERIAL: STAINLESS STEEL
MATERIAL: AÇO INOX
MATÉRIEL: ACIER INOXYDABLE

STANDARD



STAINLESS STEEL
AÇO INOX
ACIER INOXYDABLE

C

STRUCTURE | ESTRUTURA | STRUCTURE

MATERIAL: METAL
MATERIAL: METAL
MATÉRIEL: METAL

STANDARD



ANTHRACITE
ANTRACITE
ANTHRACITE
RAL 7026



GRAY
CINZA
GRIS
RAL 7035

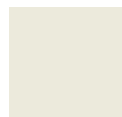

WHITE
BRANCO
BLANC
RAL 9010

OPTIONAL
OPCIONAL | OPTIONNEL



BLACK
PRETO
NOIR
RAL 9005

EN

NOTES

Optional - colors on request
fronts - edges are the same color of carcasses

PT

NOTAS

Opcional - cores sob consulta
frentes- orla da mesma cor dos corpos

FR

NOTE

Optionnel - couleurs sous demande
chants de la même couleurs que les corps

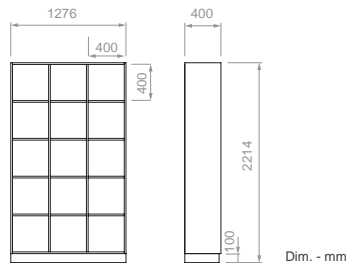

FAVOS DE ARRUMAÇÃO |
UNITÉ DE STOCKAGE

STORAGE COMBS

A

CARCASES | CORPOS | CORPS

MATERIAL: MELAMINE
MATERIAL: MELAMINA
MATÉRIEL: MÉLAMINE

STANDARD

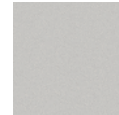

GRAY
CINZA
GRIS
U 708 - ST15

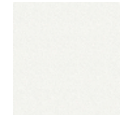

WHITE
BRANCO
BLANC
W 980 - ST2

OPTIONAL
OPCIONAL | OPTIONNEL



BLACK
PRETO
NOIR
U 999 - ST2

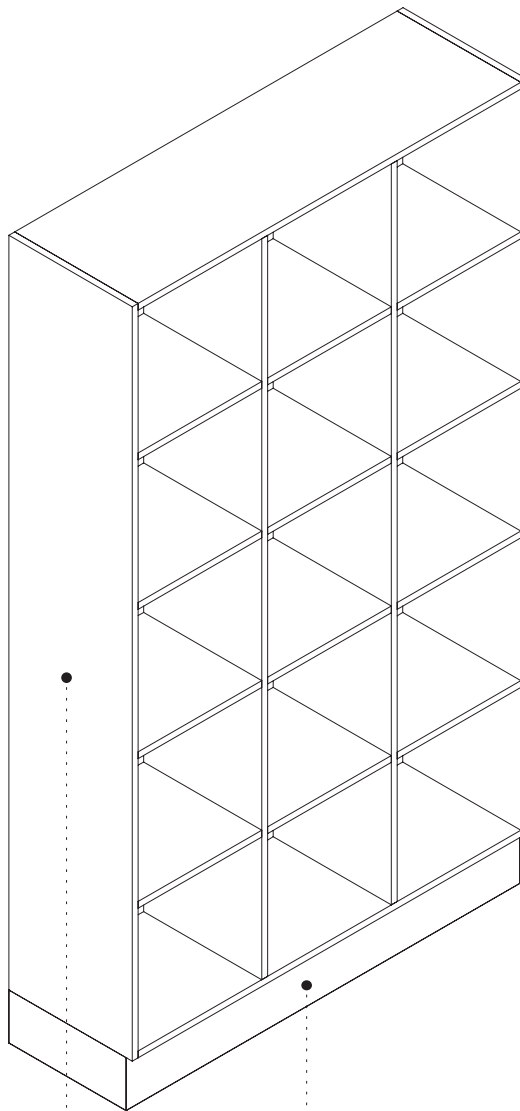

A

B

B

PLINTH | RODAPÉ | SOCLE FERMÉ

MATERIAL: METAL
MATERIAL: METAL
MATÉRIEL: METAL

STANDARD



GRAY
CINZA
GRIS
RAL 7035



WHITE
BRANCO
BLANC
RAL 9010

OPTIONAL
OPCIONAL | OPTIONNEL



BLACK
PRETO
NOIR
RAL 9005

EN

NOTES

Optional - colors on request

PT

NOTAS

Opicional - cores sob consulta

FR

NOTE

Optionnel - couleurs sous demande

MESA DE PROFESSORES |
PAILLASSE DE PROFESSEURS
TEACHER TABLE

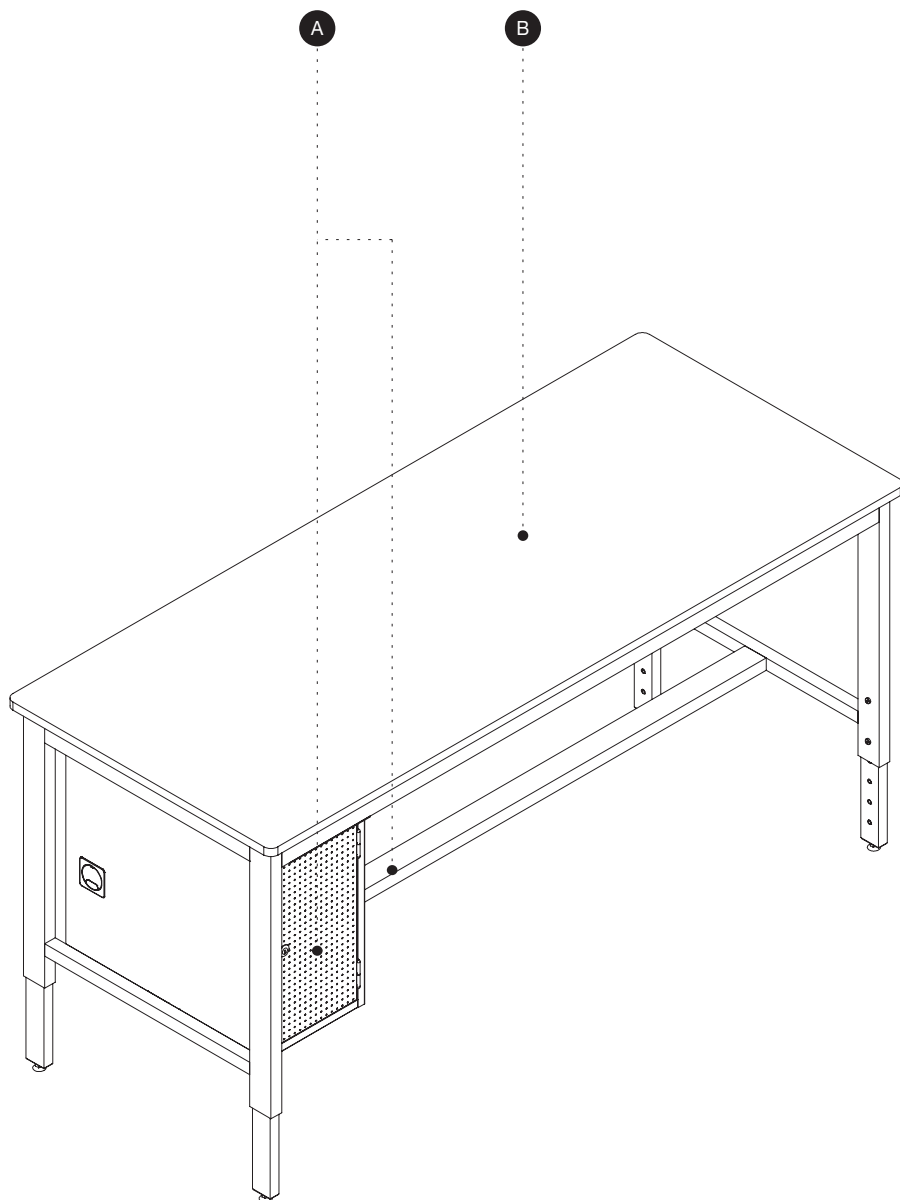
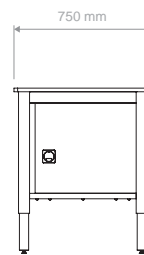
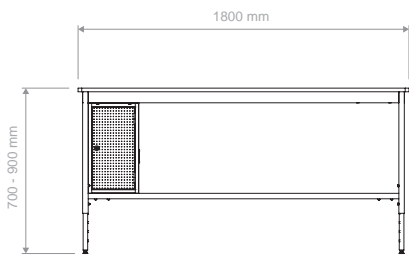

A

CPU SUPPORT + STRUCTURE
| SUPORTE CPU + ESTRUTURA |
SUPPORT D'UNITÉ CENTRALE +
STRUCTURE

MATERIAL: METAL
MATERIAL: METAL
MATÉRIEL: METAL

STANDARD



ANTHRACITE
ANTRACITE
ANTHRACITE
RAL 7026

OPTIONAL
OPCIONAL | OPTIONNEL



BLACK
PRETO
NOIR
RAL 9005

B

WORKTOP | TAMPO | PLAN DE TRAVAIL

MATERIAL: TRESPA TOPLAB PLUS
MATERIAL: TRESPA TOPLAB PLUS
MATÉRIEL: TRESPA TOPLAB PLUS

STANDARD



GRAY
CINZA
GRIS
T 03.4.0



WHITE
BRANCO
BLANC
T 03.0.0

OPTIONAL
OPCIONAL | OPTIONNEL



BLACK
PRETO
NOIR
T 90.0

EN

NOTES

Optional - colors on request

PT

NOTAS

Opcional - cores sob consulta

FR

NOTE

Optionnel - couleurs sous demande

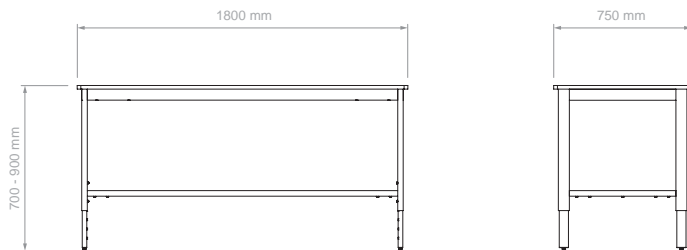

MESA DE ALUNOS |
PAILLASSE D'ÉLÈVES

STUDENT TABLE

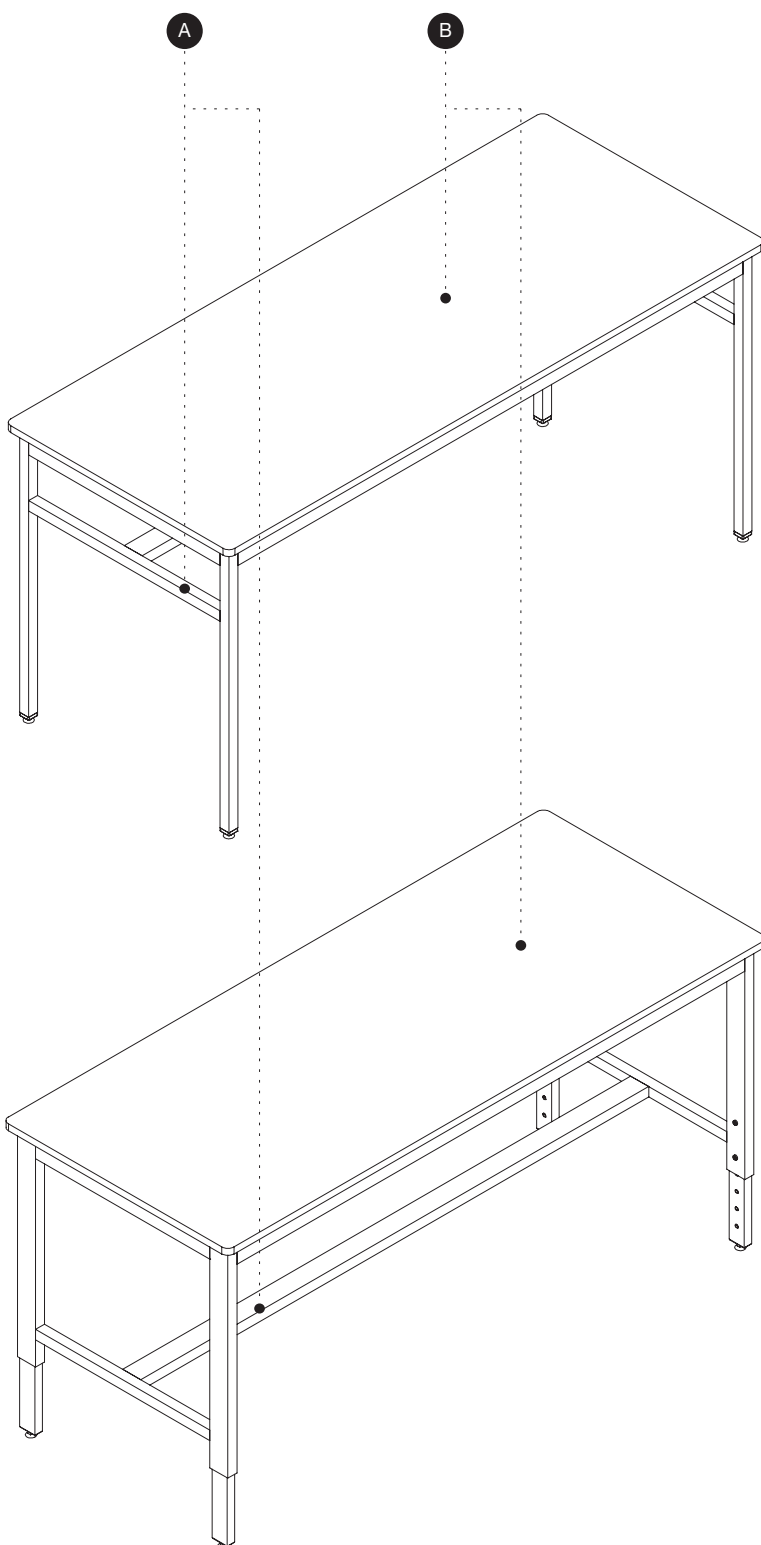

A

STRUCTURE | ESTRUTURA | STRUCTURE

MATERIAL: METAL
MATERIAL: METAL

STANDARD



GRAY
CINZA
GRIS
U 708 - ST15

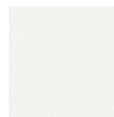

WHITE
BRANCO
BLANC
W 980 - ST2

OPTIONAL
OPCIONAL | OPTIONNEL



BLACK
PRETO
NOIR
U 999 - ST2

B

WORKTOP | TAMPO | PLAN DE TRAVAIL

MATERIAL: TRESPA TOPLAB PLUS
MATERIAL: TRESPA TOPLAB PLUS
MATERIAL: TRESPA TOPLAB PLUS

STANDARD



GRAY
CINZA
GRIS
U 708 - ST15

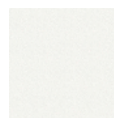

WHITE
BRANCO
BLANC
W 980 - ST2

OPTIONAL
OPCIONAL | OPTIONNEL



BLACK
PRETO
NOIR
U 999 - ST2

EN

NOTES

Optional - colors on request

PT

NOTAS

Opicional - cores sob consulta

FR

NOTE

Optionnel - couleurs sous demande

BANCADA DE SALAS DE PREPARAÇÃO |
PAILLASSE DE SALLE DE PRÉPARATION

PREPARATION ROOM BENCH

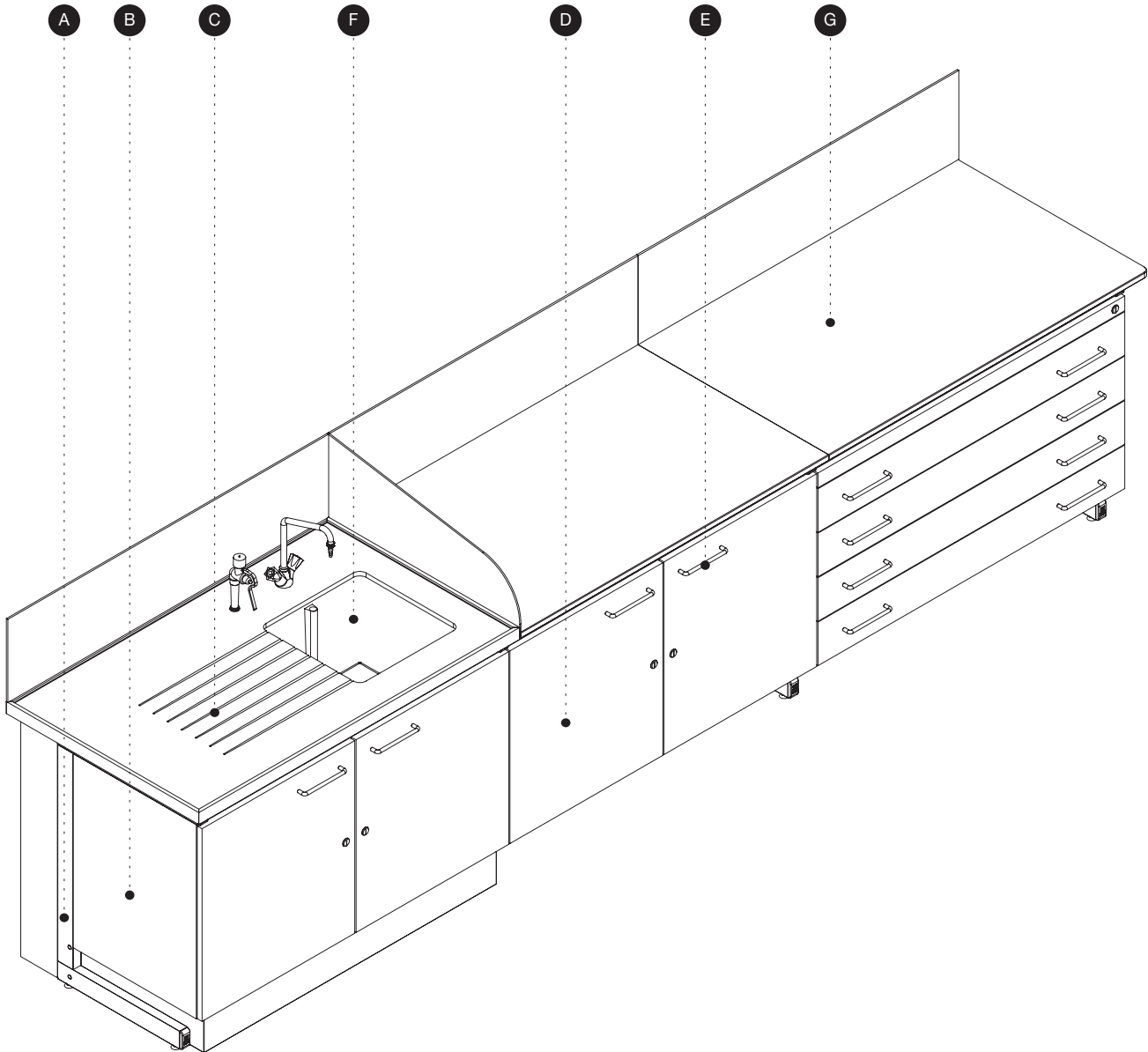
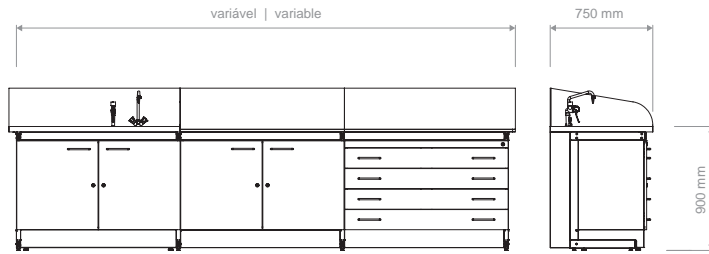

A

'C' STRUCTURE | ESTRUTURA EM 'C' |
STRUCTURE EN 'C'
MATERIAL: METAL
MATERIAL: METAL
MATÉRIEL: METAL

STANDARD



GRAY
CINZA
GRIS
RAL 7035

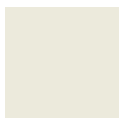

WHITE
BRANCO
BLANC
RAL 9010

OPTIONAL
OPCIONAL | OPTIONNEL



BLACK
PRETO
NOIR
RAL 9005

B

CARCASES | CORPOS | CORPS

MATERIAL: MELAMINE
MATERIAL: MELAMINA
MATÉRIEL: MÉLAMINE

STANDARD



GRAY
CINZA
GRIS
U 708 - ST15

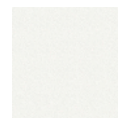

WHITE
BRANCO
BLANC
W 980 - ST2

OPTIONAL
OPCIONAL | OPTIONNEL



U 999 - ST2

C**WASHING MODULE | LAVA-LOUÇAS | ÉVIER****MATERIAL: POLYPROPYLENE**MATERIAL: POLIPROPILENO
MATÉRIEL: POLYPROPYLÈNE

STANDARD

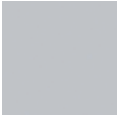
**GRAY**
CINZA
GRIS**WHITE**
BRANCO
BLANC**E****HANDLE | PUXADOR | POIGNÉE****MATERIAL: STAINLESS STEEL**MATERIAL: AÇO INOX
MATÉRIEL: ACIER INOXYDABLE

STANDARD

**STAINLESS STEEL**
AÇO INOX
ACIER INOXYDABLE**F****SINK | PIO | ÉVIER****MATERIAL: POLYPROPYLENE**MATERIAL: POLIPROPILENO
MATÉRIEL: POLYPROPYLÈNE

STANDARD

**WHITE**
BRANCO
BLANC**G****WORKTOP | TAMPO | PLAN DE TRAVAIL****MATERIAL: TRESPA TOPLAB PLUS**MATERIAL: TRESPA TOPLAB PLUS
MATÉRIEL: TRESPA TOPLAB PLUS

STANDARD

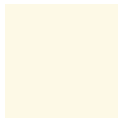
**GRAY**
CINZA
GRIS
T 03.4.0**WHITE**
BRANCO
BLANC
T 03.0.0OPTIONAL
OPCIONAL | OPTIONNEL**BLACK**
PRETO
NOIR
T 90.0

EN

NOTESOptional - colors on request
fronts - edges are the same color of carcasses

PT

NOTASOpcional - cores sob consulta
frentes- orla da mesma cor dos corpos

FR

NOTEOptionnel - couleurs sous demande
chants de la même couleurs que les corps**D****OPAQUE FRONTS | FRENTES OPACAS | FAÇADES OPAQUE****MATERIAL: MELAMINE**MATERIAL: MELAMINA
MATÉRIEL: MÉLAMINE

STANDARD

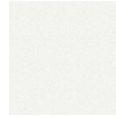
**GRAY**
CINZA
GRIS
U 708 - ST15**WHITE**
BRANCO
BLANC
W 980 - ST2OPTIONAL
OPCIONAL | OPTIONNEL

U 104 - ST15



U 114 - ST15



U 143 - ST15



U 332 - ST15



U 518 - ST9

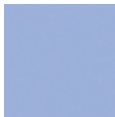

U 522 - ST15



U 525 - ST15



U 536 - ST15



U 625 - ST15



U 632 - ST15



U 999 - ST2



F 501 - ST2

ARMÁRIO ESTANTE |
ARMOIRE ÉTAGÈRE
TALL CABINET

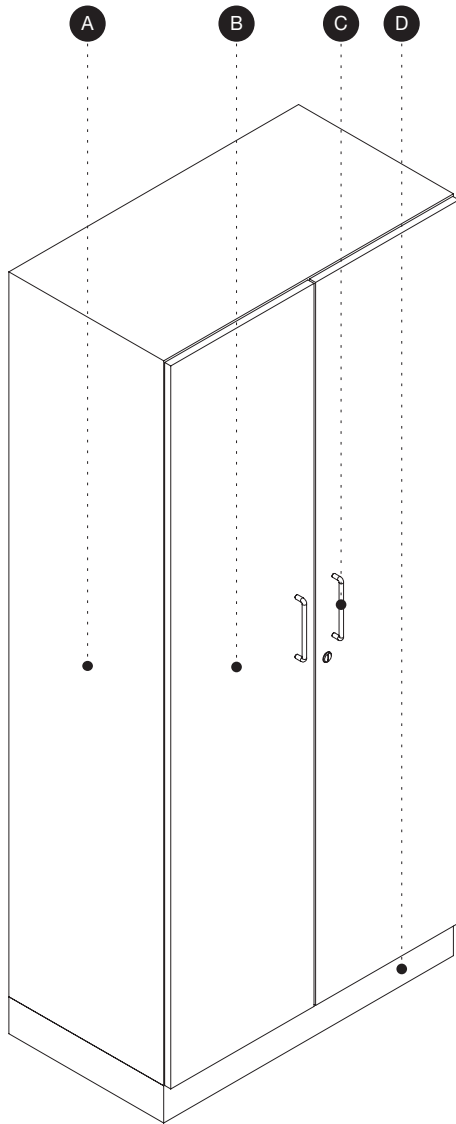
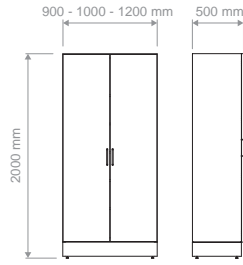

A
CARCASE | CORPO | CORPS

MATERIAL: MELAMINE
MATERIAL: MELAMINA
MATÉRIEL: MÉLAMINE

STANDARD



GRAY
CINZA
GRIS
U 708 - ST15

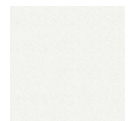

WHITE
BRANCO
BLANC
W 980 - ST2

OPTIONAL
OPCIONAL | OPTIONNEL



U 999 - ST2

EN

NOTES

Optional - colors on request

PT

NOTAS

Opcional - cores sob consulta

FR

NOTE

Optionnel - couleurs sous demande

B**FRONTS | FRENTEs | FAÇADES****MATERIAL: MELAMINE**MATERIAL: MELAMINA
MATÉRIEL: MÉLAMINE

STANDARD

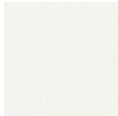
**GRAY**
CINZA
GRIS
U 708 - ST15**WHITE**
BRANCO
BLANC
W 980 - ST2OPTIONAL
OPCIONAL | OPTIONNEL

U 104 - ST15



U 114 - ST15



U 143 - ST15



U 332 - ST15



U 518 - ST9

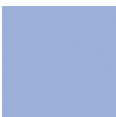

U 522 - ST15



U 525 - ST15



U 536 - ST15



U 625 - ST15



U 632 - ST15



U 999 - ST2

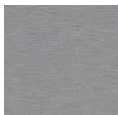

F 501 - ST2

C**PLINTH | RODAPÉ | SOCLE FERMÉ****MATERIAL: METAL**MATERIAL: METAL
MATÉRIEL: METAL

STANDARD

**GRAY**
CINZA
GRIS
RAL 7035**WHITE**
BRANCO
BLANC
RAL 9010OPTIONAL
OPCIONAL | OPTIONNEL**BLACK**
PRETO
NOIR
RAL 9005**D****HANDLE | PUXADOR | POIGNÉE****MATERIAL: STAINLESS STEEL**MATERIAL: AÇO INOX
MATÉRIEL: ACIER INOXYDABLE

STANDARD

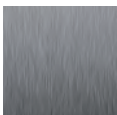
**STAINLESS STEEL**
AÇO INOX
ACIER INOXYDABLE

HOTTE + ARMÁRIO PARA
 ÁCIDOS E BASES |
 SORBONNE + ARMOIRE POUR
 ACIDES ET BASES

FUME CUPBOARD + ACIDS AND BASES STORAGE CABINET

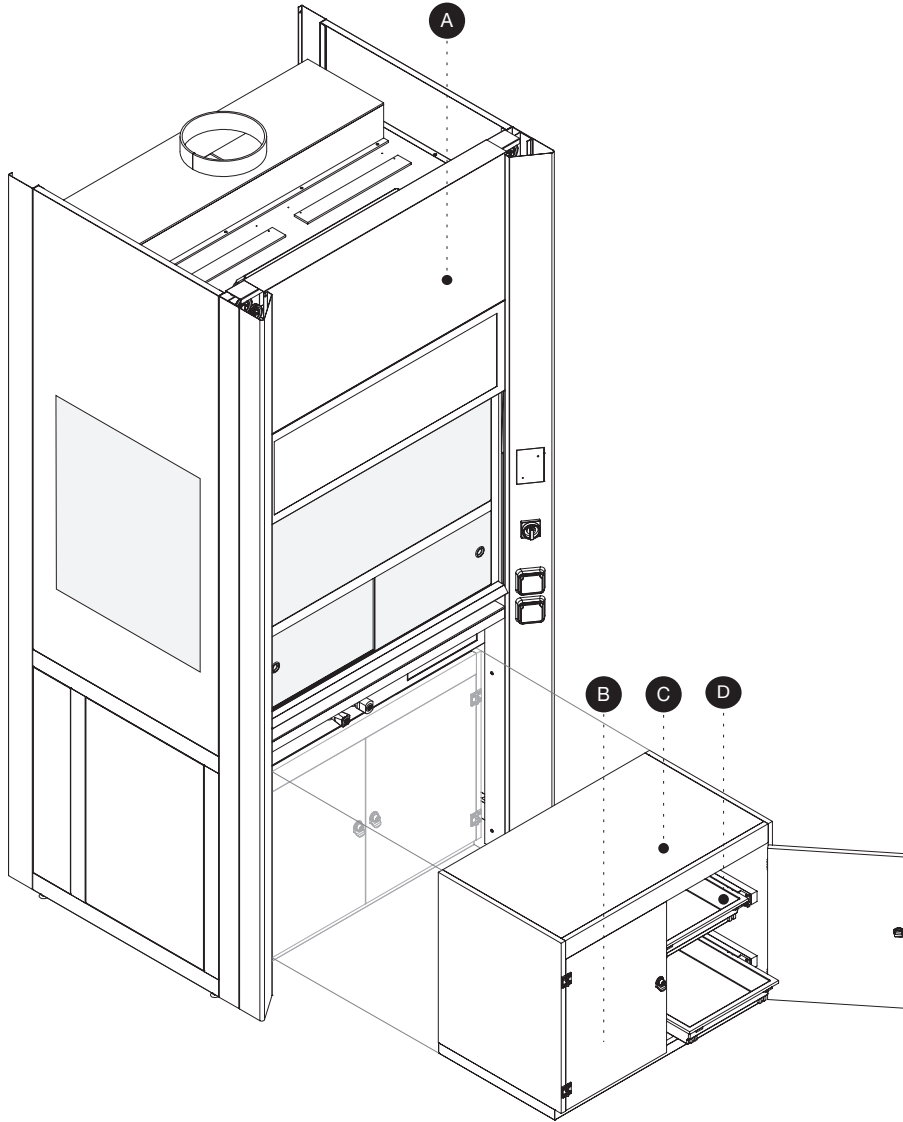
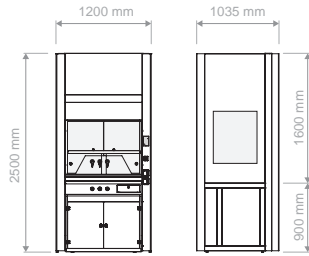

A

FUME CUPBOARD | HOTTE | SORBONNE

MATERIAL: METAL
 MATERIAL: METAL
 MATÉRIEL: METAL

STANDARD



GRAY
 CINZA
 GRIS
 RAL 7035

B

FRONTS | FRENTE | FAÇADES

MATERIAL: HPL
 MATERIAL: HPL
 MATÉRIEL: HPL

STANDARD



HIGH GLOSS GRAY
 CINZA ALTO BRILHO
 GRIS BRILLANT

C

CARCASE | CORPO | CORPS

MATERIAL: MELAMINE
 MATERIAL: MELAMINA
 MATÉRIEL: MÉLAMINE

STANDARD



GRAY
 CINZA
 GRIS
 U 708 - ST15

EN

NOTES

Optional[Fume Cupboard] - colors on request

D

TRAYS | TABULEIROS | PLATEAUX

MATERIAL: POLYPROPYLENE
 MATERIAL: POLIPROPILENO
 MATÉRIEL: POLYPROPYLENE

STANDARD

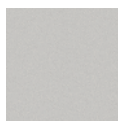

GRAY
 CINZA
 GRIS

PT

NOTAS

Opcional [Hotte]- cores sob consulta

FR

NOTE

Optionnel [Sorbonne] - couleurs sous demande

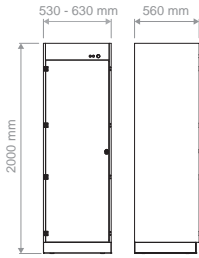

ARMÁRIO PARA SUBSTÂNCIAS
CORROSIVAS |
ARMOIRE POUR SUBSTANCES
CORROSIVES

CABINET FOR CORROSIVE SUBSTANCES

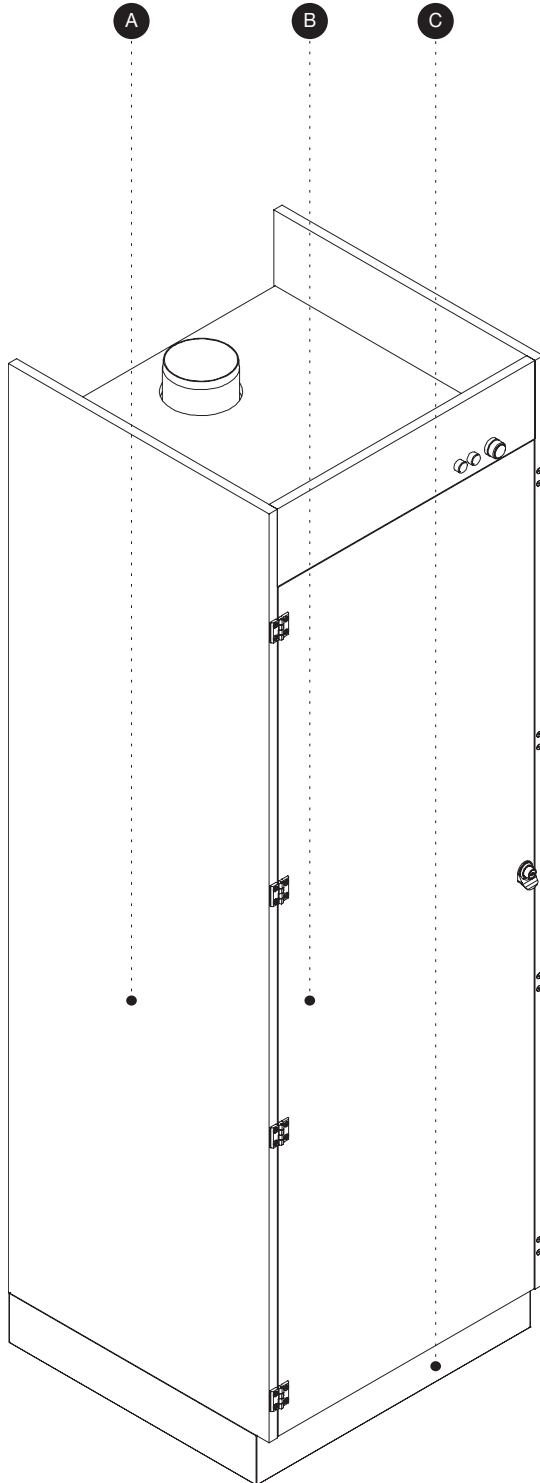

A

CARCASE | CORPO | CORPS

MATERIAL: MELAMINE

MATERIAL: MELAMINA

MATÉRIEL: MÉLAMINE

STANDARD



GRAY

CINZA

GRIS

U 708 - ST15

B

FRONTS | FRENTE | FAÇADES

MATERIAL: HPL

MATERIAL: HPL

MATÉRIEL: HPL

STANDARD



HIGH GLOSS GRAY

CINZA ALTO BRILHO

GRIS BRILLANT

C

PLINTH | RODAPÉ | SOCLE FERMÉ

MATERIAL: METAL

MATERIAL: METAL

MATÉRIEL: METAL

STANDARD



GRAY

CINZA

GRIS

RAL 7035

EN

NOTES

Optional - colors on request

PT

NOTAS

Opcional - cores sob consulta

FR

NOTE

Optionnel - couleurs sous demande

ARMÁRIO PARA PRODUTOS
INFLAMÁVEIS |
ARMOIRE DE PRODUITS
INFLAMMABLES

CABINET FOR FLAMMABLE PRODUCTS

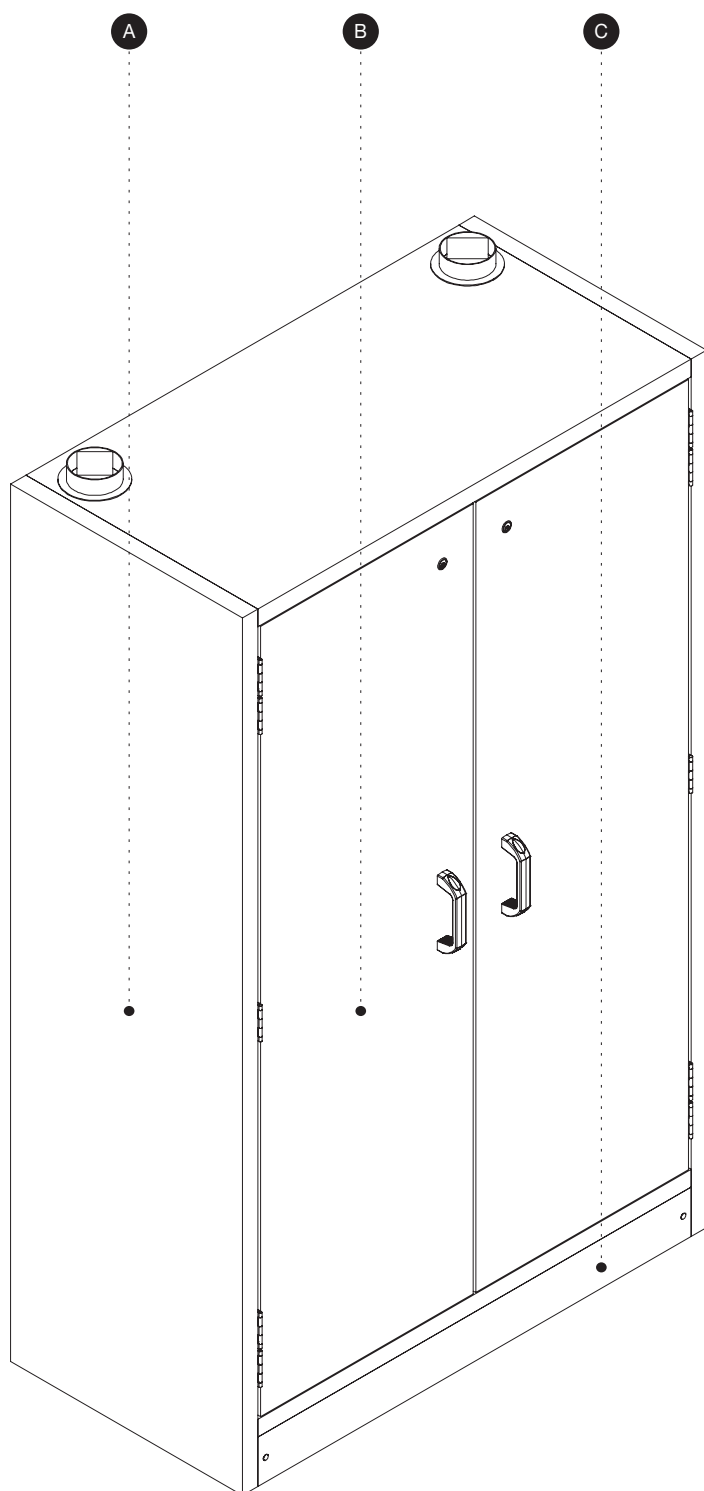
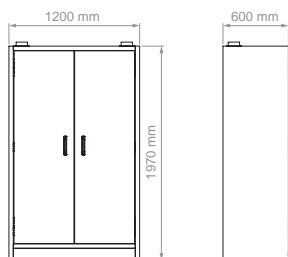

A

CARCASE | CORPO | CORPS

STANDARD



GRAY
CINZA
GRIS

B

FRONTS | FRENTES | FAÇADES

STANDARD



HIGH GLOSS GRAY
CINZA ALTO BRILHO
GRIS BRILLANT

C

PLINTH | RODAPÉ | SOCLE FERMÉ

STANDARD



GRAY
CINZA
GRIS



UNIÃO EUROPEIA

Fundo Europeu de
Desenvolvimento Regional

sede | head office | siège
Rua Marcelino Sá Pires, nº 15, 5º sala 56
São José de São Lázaro
4700-924 Braga . Portugal

delegação comercial | trade delegation | délégation commerciale

Rua Professor Hernâni Cidade 11b
1600-631 Lisboa . Portugal

instalações fabris | premises | installations de production

Sobreiro Torto, Branca - apt.187
3854-909 Albergaria-a-Velha . Portugal
T +351 234 529 500
F +351 234 525 263

