

PURE  
[pyoo r]

adjective, purer, purest.

free from anything of a different, inferior, or contaminating kind; free from extraneous matter; unmodified by an admixture; simple or homogeneous. free from foreign or inappropriate elements.

Synonyms

unmixed, unadulterated, unalloyed, uncontaminated, untainted, unstained, undefiled, untarnished, immaculate, unpolluted, uncorrupted.

PAVIGRÉS®  
GRUPO



**FERI & MASI**  
PUREVER TILES





UNIQUE NATIVE 89X89cm + STAINLESS STEEL FIXING KIT  
[BÉTON SMART]

Feri & Masi, is a Portuguese brand of Pavigrés Group, specialized in the manufacture of porcelain tiles with an outstanding know-how in unglazed double-loaded products.

Worldwide present, the Pavigrés Group is proud of its quality heritage and focus on what is truly essential: simplicity and beauty.

In the PURE catalogue we present three Architectural Collections, offering completely unglazed porcelain tiles made by a unique full body, double and triple-loading process with hyper granulometric reduction. The PURE products are the nature in its purest state and are proudly made to bring us back to basics, back to the material.

Feri & Masi é uma marca portuguesa do Grupo Pavigrés, especializada na produção de pavimento e revestimento em grés porcelânico. Temos um extraordinário know-how na fabricação de produtos não esmaltados feitos com recurso à tecnologia de dupla-carga.

Presente em todo mundo, o Grupo Pavigrés orgulha-se na elevada qualidade que lhe é reconhecida e trabalha diariamente focada no que é verdadeiramente essencial: simplicidade e beleza.

No catálogo PURE apresentamos três coleções de arquitetura, constituídas por produtos não esmaltados, fabricados com recurso a um singular processo de toda a massa, dupla e tripla-carga com hiper redução granulométrica. Os produtos PURE oferecem-nos a natureza no seu estado mais puro. Conduzem-nos de volta à gênese, de volta à matéria.



PAVIGRÉS<sup>®</sup>  
GRUPO

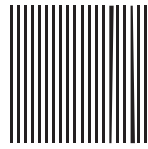

**FERI & MASI**  
PUREVER TILES

COASTLAND	07
UNIQUE	31
GRANITY AIR	57
ENVIRONMENTAL PROTECTION	90
MODULARITY & SHADE VARIATION	106
CLEANING & MAINTENANCE	107
REFERENCE PROJECTS	108



## COASTLANDCOLLECTION

5 COLORS  
4 SIZES  
2 SURFACES

Coastland is an impressive Collection inspired in the most beautiful seashores. With Nature in mind, we build a color palette matching the most remarkable worldwide beaches, from the volcanic black sands to the pure white shores of the Pacific.

Coastland is a sophisticated technical porcelain tile of complex engineering, its architecture took us some years of development pairing it with the most recent technologies and research.

Coastland is now a flawless product, suitable for all areas and highly endorsed for high traffic places due to its superb technical performance.

Presented in two distinct surfaces, Coastland is unveiled in four different sizes and five Nature based colors.

Coastland é uma coleção impressionante inspirada nas belas costas marítimas. Com o foco na Natureza, construímos uma paleta de cores que corresponde às mais singulares praias do mundo que vão desde as areias negras de origem vulcânica até às margens brancas do Pacífico.

A Coastland é um porcelânico técnico sofisticado de engenharia complexa, a sua arquitetura levou alguns anos a desenvolver e está a par com as mais recentes tecnologias e investigação.

Coastland é um produto notável, adequado para todas as áreas mas altamente recomendado para locais de elevado tráfego devido ao seu soberbo desempenho técnico.

Apresentado em duas superfícies distintas, Coastland revela-se em quatro formatos diferentes e cinco cores baseadas na Natureza.

COASTLAND WHITE 89X89cm  
[HAMMERED EFFECT R12C]

COASTLAND BLACK 89X89cm  
[MATT R10B]



COASTLANDSURFACES

MATT R10B

HAMMERED EFFECT R12C



COASTLANDCOLLECTION



COASTLAND GREIGE 59,7x119cm  
[MATT RIOB]



COASTLANDCOLLECTION

COASTLAND GREIGE 59,7x119cm.  
[MATT RIOB]



# COASTLANDBLACK

10,5mm

59,7X119cm 24"X47"



**MATT | MATE [R10B] - FM3173MT**  
**HAMMERED EFFECT | BOUCHARDÉ | BUJARDADO [R12C] - FM3177EF**

59,7X59,7cm 24"X24"



**MATT | MATE [R10B] - FM3174MT**  
**HAMMERED EFFECT | BOUCHARDÉ | BUJARDADO [R12C] - FM3178EF**

59,7X59,7cm 24"X24"



**MATT | MATE [R10B] - FM3182MT**  
**HAMMERED EFFECT | BOUCHARDÉ | BUJARDADO [R12C] - FM3186EF**

59,7X119cm 24"X47"



**MATT | MATE [R10B] - FM3181MT**  
**HAMMERED EFFECT | BOUCHARDÉ | BUJARDADO [R12C] - FM3185EF**

89X89cm 35"X35"



**MATT | MATE [R10B] - FM3172MT**  
**HAMMERED EFFECT | BOUCHARDÉ | BUJARDADO [R12C] - FM3176EF**

29,7X59,7cm 12"X24"



**MATT | MATE [R10B] - FM3175MT**  
**HAMMERED EFFECT | BOUCHARDÉ | BUJARDADO [R12C] - FM3179EF**

29,7X59,7cm 12"X24"



**MATT | MATE [R10B] - FM3183MT**  
**HAMMERED EFFECT | BOUCHARDÉ | BUJARDADO [R12C] - FM3187EF**

89X89cm 35"X35"



**MATT | MATE [R10B] - FM3180MT**  
**HAMMERED EFFECT | BOUCHARDÉ | BUJARDADO [R12C] - FM3184EF**

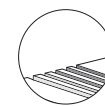
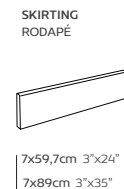
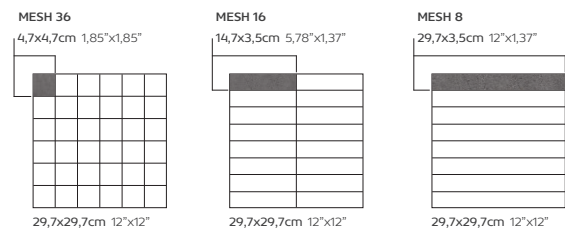

ENHANCED STEPS WITH 5 GROVES  
DEGRAUS APERFEIÇADOS COM 5 RASGOS

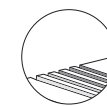
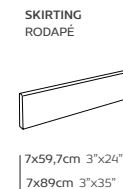
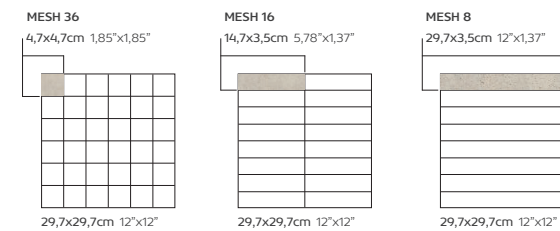
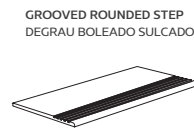
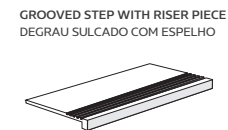

ENHANCED STEPS WITH 5 GROVES  
DEGRAUS APERFEIÇADOS COM 5 RASGOS

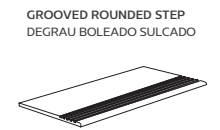
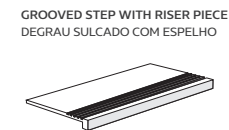

# COASTLANDGREIGE

10,5mm



coffeeparadise

WAKEUP  COFFEE

COASTLANDCOLLECTION

trend & style

HES  
tum.

trend & style  
NEW YORK



COASTLANDCOLLECTION



COASTLAND BEIGE 89X89cm  
[MATT R10B]



# COASTLANDWHITE

10,5mm

59,7X119cm 24"X47"



**MATT | MATE [R10B] - FM3189MT**  
**HAMMERED EFFECT | BOUCHARDÉ | BUJARDADO [R12C] - FM3193EF**

89X89cm 35"X35"



**MATT | MATE [R10B] - FM3188MT**  
**HAMMERED EFFECT | BOUCHARDÉ | BUJARDADO [R12C] - FM3192EF**

59,7X59,7cm 24"X24"

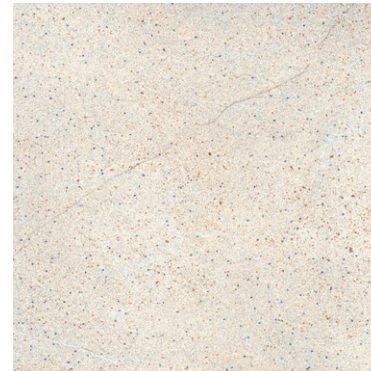

**MATT | MATE [R10B] - FM3190MT**  
**HAMMERED EFFECT | BOUCHARDÉ | BUJARDADO [R12C] - FM3194EF**

29,7X59,7cm 12"X24"



**MATT | MATE [R10B] - FM3191MT**  
**HAMMERED EFFECT | BOUCHARDÉ | BUJARDADO [R12C] - FM3195EF**

59,7X59,7cm 24"X24"



**MATT | MATE [R10B] - FM3166MT**  
**HAMMERED EFFECT | BOUCHARDÉ | BUJARDADO [R12C] - FM3170EF**

29,7X59,7cm 12"X24"



**MATT | MATE [R10B] - FM3167MT**  
**HAMMERED EFFECT | BOUCHARDÉ | BUJARDADO [R12C] - FM3171EF**

59,7X119cm 24"X47"



**MATT | MATE [R10B] - FM3165MT**  
**HAMMERED EFFECT | BOUCHARDÉ | BUJARDADO [R12C] - FM3169EF**

89X89cm 35"X35"



**MATT | MATE [R10B] - FM3164MT**  
**HAMMERED EFFECT | BOUCHARDÉ | BUJARDADO [R12C] - FM3168EF**

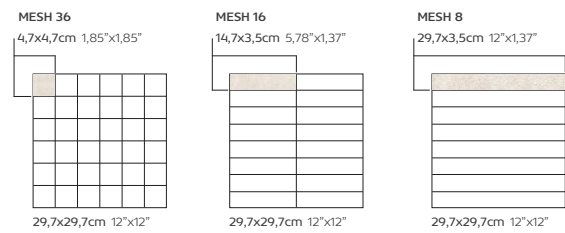

SKIRTING  
RODAPÉ



7x59,7cm 3"x24"  
7x89cm 3"x35"

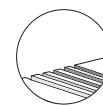

ENHANCED STEPS WITH 5 GROOVES  
DEGRAUS APERFEIÇOADOS COM 5 RASGOS

GROOVED STEP WITH RISER PIECE  
DEGRAU SULCADO COM ESPELHO

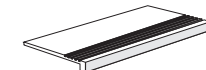

29,7x59,7cm 12"x24"

GROOVED ROUNDED STEP  
DEGRAU BOLEADO SULCADO



29,7x59,7cm 12"x24"

# COASTLANDBEIGE

10,5mm





COASTLAND WHITE 59,7x59,7cm  
[MATT RIOB]



COASTLANDCOLLECTION

COASTLAND KHAKEI 59,7x59,7cm  
[MATT R10B]





59,7X59,7cm 24"X24"



**MATT | MATE [R10B] - FM3155MT**  
**HAMMERED EFFECT | BOUCHARDÉ | BUJARDADO [R12C] - FM3158EF**

59,7X119cm 24"X47"



**MATT | MATE [R10B] - FM3154MT**  
**HAMMERED EFFECT | BOUCHARDÉ | BUJARDADO [R12C] - FM3157EF**

29,7X59,7cm 12"X24"



**MATT | MATE [R10B] - FM3156MT**  
**HAMMERED EFFECT | BOUCHARDÉ | BUJARDADO [R12C] - FM3159EF**

89X89cm 35"X35"



**MATT | MATE [R10B] - FM3148MT**  
**HAMMERED EFFECT | BOUCHARDÉ | BUJARDADO [R12C] - FM3160EF**

COASTLAND KHAKI 59,7x59,7cm  
 [MATT R10B]

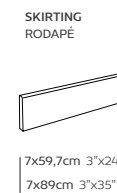
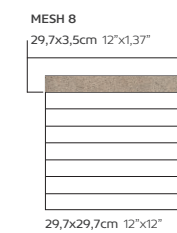
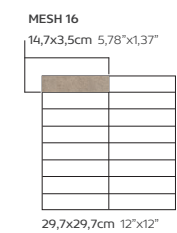
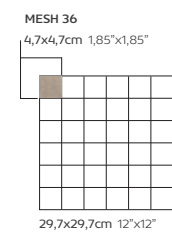



**U** SCRATCH RESISTANCE  
RESISTANCE À L'ABRASION  
RESISTÊNCIA À ABRASÃO

**P** BREAKING STRENGTH  
RESISTANCE À LA FLEXION  
RESISTÊNCIA MECÂNICA

**E** BEHAVIOUR IN WATER PRESENCE  
COMPORTEMENT EN PRÉSENCE D'EAU  
COMPORTAMENTO EM PRESENÇA DE ÁGUA

**C** BEHAVIOUR IN PRESENCE OF CHEMICAL PRODUCTS  
COMPORTEMENT EN PRÉSENCE DE PRODUITS CHIMIQUES  
COMPORTAMENTO EM PRESENÇA DE PRODUTOS QUÍMICOS

UPEC
U2
U2S
U3
U3S
U4



## COASTLAND

REFERENCE:	PRODUCT/COLOR:	SIZE:	CLASSIFICATION:
FM3164MT	Coastland Beige	890x890x10.5	U4P3E3C2
FM3165MT	Coastland Beige	597x1190x10.5	U4P3E3C2
FM3166MT	Coastland Beige	597x597x10.5	U4P4E3C2
FM3167MT	Coastland Beige	297x597x10.5	U4P4E3C2
FM3168EF	Coastland Beige	890x890x10.5	U4P3E3C2
FM3169EF	Coastland Beige	597x1190x10.5	U4P3E3C2
FM3170EF	Coastland Beige	597x597x10.5	U4P4E3C2
FM3171EF	Coastland Beige	297x597x10.5	U4P4E3C2
FM3172MT	Coastland Black	890x890x10.5	U4P3E3C2
FM3173MT	Coastland Black	597x1190x10.5	U4P3E3C2
FM3174MT	Coastland Black	597x597x10.5	U4P4E3C2
FM3175MT	Coastland Black	297x597x10.5	U4P4E3C2
FM3176EF	Coastland Black	890x890x10.5	U4P3E3C2
FM3177EF	Coastland Black	597x1190x10.5	U4P3E3C2
FM3178EF	Coastland Black	597x597x10.5	U4P4E3C2
FM3179EF	Coastland Black	297x597x10.5	U4P4E3C2
FM3180MT	Coastland Greige	890x890x10.5	U4P3C3E2
FM3181MT	Coastland Greige	597x1190x10.5	U4P3E3C2
FM3182MT	Coastland Greige	597x597x10.5	U4P4E3C2
FM3183MT	Coastland Greige	297x597x10.5	U4P4E3C2
FM3184EF	Coastland Greige	890x890x10.5	U4P3E3C2
FM3185EF	Coastland Greige	597x1190x10.5	U4P3E3C2
FM3186EF	Coastland Greige	597x597x10.5	U4P4E3C2
FM3187EF	Coastland Greige	297x597x10.5	U4P4E3C2
FM3148MT	Coastland Khaki	890x890x10.5	U4P3E3C2
FM3154MT	Coastland Khaki	597x1190x10.5	U4P3E3C2
FM3155MT	Coastland Khaki	597x597x10.5	U4P4E3C2
FM3156MT	Coastland Khaki	297x597x10.5	U4P4E3C2
FM3157EF	Coastland Khaki	597x1190x10.5	U4P3E3C2
FM3158EF	Coastland Khaki	597x597x10.5	U4P4E3C2
FM3159EF	Coastland Khaki	297x597x10.5	U4P4E3C2
FM3160EF	Coastland Khaki	890x890x10.5	U4P3E3C2
FM3188MT	Coastland White	890x890x10.5	U4P3E3C2
FM3189MT	Coastland White	597x1190x10.5	U4P3E3C2
FM3190MT	Coastland White	597x597x10.5	U4P4E3C2
FM3191MT	Coastland White	297x597x10.5	U4P4E3C2
FM3192EF	Coastland White	890x890x10.5	U4P3E3C2
FM3193EF	Coastland White	597x1190x10.5	U4P3E3C2
FM3194EF	Coastland White	597x597x10.5	U4P4E3C2
FM3195EF	Coastland White	297x597x10.5	U4P4E3C2

## MATERIAL

TECHNICAL PORCELAIN TILE

### PRODUCTION

SINGLE-LOADING TECHNOLOGY WITH POWDER HOMOGENIZATION AND HIGH GRANULOMETRY REDUCTION  
HYDRAULIC ISOSTATIC VERTICAL PRESSING [ ≥ 500Kg/cm<sup>2</sup> ]  
SINGLE FIRING WITH EXTRA LONG CYCLE AND HIGH TEMPERATURE [ 1220-1230°C ]  
AUTOMATIC SQUARING AND RECTIFYING OPERATIONS FOR ALL PIECES

## COASTLAND

TECHNICAL FEATURES: DADOS TÉCNICOS: EN 14411; ANNEXE G   ANEXO G; GRUPO   GRUPO   GRUPO Bla	STANDARDS SPECIFICATIONS VALORES NORMAS	COASTLAND AVERAGE VALUES VALORES MÉDIOS	TEST NORM NORMA DE ENSAIO
<b>LENGTH AND WIDTH TOLERANCE</b> DESVIO MÁXIMO PARA COMPRIMENTO E LARGURA	± 0,6%	± 0,3%	
<b>THICKNESS TOLERANCE</b> DESVIO MÁXIMO PARA ESPESSURA	± 5%	± 3%	
<b>STRAIGHTNESS OF SIDES TOLERANCE</b> DESVIO MÁXIMO DA RECTILINEARIDADE	± 0,5%	± 0,3%	ISO 10545-2
<b>RECTANGULARITY TOLERANCE</b> DESVIO MÁXIMO DA ORTOGONALIDADE	± 0,5%	± 0,3%	
<b>FLATNESS TOLERANCE</b> DESVIO MÁXIMO DE PLANARIDADE	± 0,5%	± 0,3%	
<b>WATER ABSORPTION</b> ABSORÇÃO DE ÁGUA	≤ 0,5%	≤ 0,1%	ISO 10545-3
<b>MODULUS OF RUPTURE</b> MÓDULO DE RUPTURA	≥ 35 N/mm <sup>2</sup>	≥ 45 N/mm <sup>2</sup>	ISO 10545-4
<b>BREAKING STRENGTH</b> FORÇA DE RUPTURA	≥ 1300 N	≥ 2500 N	
<b>DEEP ABRASION RESISTANCE</b> RESISTÊNCIA À ABRASÃO PROFUNDA	≤ 175 mm <sup>2</sup>	≤ 130 mm <sup>2</sup>	ISO 10545-6
<b>LINEAR THERMAL EXPANSION</b> DILATAÇÃO TÉRMICA LINEAR	<b>DECLARED VALUE</b> VALOR DECLARADO	≤ 7X10 <sup>-6</sup> / K <sup>-1</sup>	ISO 10545-8
<b>THERMAL SHOCK RESISTANCE</b> RESISTÊNCIA AO CHOQUE TÉRMICO	<b>ORDERED</b> REQUERIDA	<b>RESISTANT</b> RESISTENTE	ISO 10545-9
<b>FROST RESISTANCE</b> RESISTÊNCIA AO GELO	<b>ORDERED</b> REQUERIDA	<b>RESISTANT</b> RESISTENTE	ISO 10545-12
<b>RESISTANCE TO CHEMICALS</b> (ACIDS AND ALKALIS) RESISTÊNCIA AOS QUÍMICOS (ÁCIDOS E BASES)	<b>DECLARED VALUE</b> VALOR DECLARADO	<b>CLASS HA</b> CLASSE HA	ISO 10545-13
<b>RESISTANCE TO CHEMICALS</b> (HOUSEHOLD CHEMICALS & SWIMMING POOL ADDITIVES) RESISTÊNCIA AOS QUÍMICOS (PRODUTOS QUÍMICOS DOMÉSTICOS E ADITIVOS PARA ÁGUA DE PISCINAS)	<b>MINIMUM CLASS B</b> MÍNIMO CLASSE B	<b>CLASS VA</b> CLASSE VA	
<b>STAIN RESISTANCE</b> RESISTÊNCIA À MANCHA	<b>DECLARED VALUE</b> VALOR DECLARADO	5	ISO 10545-14
<b>SLIP RESISTANCE</b> RESISTÊNCIA AO ESCORREGAMENTO	<b>CLASS A</b> ≥ 12° <b>CLASS B</b> ≥ 18° <b>CLASS C</b> ≥ 24°  <b>R9</b> 6° - 10° <b>R10</b> 10° - 19° <b>R11</b> 19° - 27° <b>R12</b> 27° - 35° <b>R13</b> > 35°	<b>MATT</b> NATURAL [MT] B <b>HAMMERED EFFECT</b> EFEITO BUJARDADO [EF] C  <b>MATT</b> NATURAL [MT] R10 <b>HAMMERED EFFECT</b> EFEITO BUJARDADO [EF] R12	DIN 51097   DIN 51130



It is guaranteed the compliance with the values required by the norm EN 14411. Typical value is merely indicative and can differ from real data. | La conformité à la norme EN14411 est garantie. La valeur typique annoncée est purement indicative, pouvant différer des valeurs réelles. | É garantido o cumprimento da norma EN14411. O valor típico anunciado é meramente indicativo, podendo variar dos dados reais.

\*\* test carried out by certified external laboratories whose results are available upon request at our head office. pavigres is willing to check the lot you are interested in purchasing at our own laboratories. the anti-slip performance is guaranteed at the time of delivering the product. | Tests effectués par des laboratoires extérieurs accrédités et à la disposition de toute personne intéressée auprès de nos bureaux. pavigres est disponible pour vérifier dans ses laboratoires un lot qui vous souhaitez acheter. la performance antidérapante est garantie au moment de la livraison du produit. | Testes efetuados por laboratórios exteriores acreditados cujos resultados estão disponíveis na nossa sede sob solicitação. a pavigres está disponível para verificar nos seus laboratórios um lote que pretendam adquirir. a performance antiderrapante é garantida a altura da entrega do produto.

⚠ No claims accepted after ceramic tiles are fixed | Aucune réclamation ne sera acceptée après la pose du carrelage | Não se aceitam reclamações depois do mosaico cerâmico aplicado.







## UNIQUE COLLECTION

3 COLORS  
3 SIZES  
3 SURFACES

Unique is a stunning Collection of unglazed double and triple-loaded porcelain stoneware. It offers an endless number of concrete plates with incomparable raw touch and ultimate design.

This exclusive Collection achieves the real identity of concrete through a very ingenious production process.

It starts with the double-loading operation made with powder homogenization and hiper granulometry reduction, providing a grain diameter with less than 150µm. When producing UNIQUE BE and UNIQUE BS a third loading is applied using GRT-Grain Repulsion Technology®.

As a result, we get a very compact powder pressed by hydraulic isostatic vertical presses with more than 500 kgf/cm<sup>2</sup>. Pieces are then shaped through a high-speed mechanical process and fired in an extra long cycle at the temperature of 1230°C.

Automatic squaring and rectification operations are finally performed in all pieces to guarantee squareness, monocaliber and modularity.

Unique é uma Coleção deslumbrante feita em grés porcelânico não esmaltado de duplo e triplo carregamento. Este produto oferece um número infinito de placas de betão com um toque cru inigualável e um design de vanguarda.

Trata-se de uma Coleção exclusiva que alcança a verdadeira identidade do betão através de um processo de produção altamente inovador.

Tudo começa com a operação de duplo carregamento feita depois da homogeneização do pó e da hiper-redução granulométrica, de onde resulta um grão com diâmetro inferior a 150µm. Ao produzir a UNIQUE BE e a UNIQUE BS é feito um terceiro carregamento com recurso à tecnologia de repulsão granulométrica, GRT - Grain Repulsion Technology®.

O fino pó obtido é sujeito a uma força de 500 kgf/cm<sup>2</sup> através de operações de prensagem com recurso a prensas hidráulicas isostáticas verticais. As peças são posteriormente modeladas através de um processo mecânico de alta velocidade e cozidas em ciclo extra longo à temperatura de 1230°C.

Por fim são realizadas as operações de esquadatura e rectificação por forma a garantir um só calibre, esquadria e modularidade.



UNIQUE COLLECTION

UNIQUE NATIVE 59,7x119cm  
[BÉTON]



UNIQUE WHITE 59,7x119cm + IRON DECOR KIT  
[BÉTON SMART]





UNIQUE COLLECTION



UNIQUE WHITE 59,7X119cm + STAINLESS STEEL FIXING KIT  
[BÉTON SMART]

CONCRETE GREY 59,7X59,7cm  
[NATURE R10A]



# UNIQUE COLLECTION



UNIQUE NATIVE 59,7X119cm + STAINLESS STEEL DECOR KIT  
[BETON SMART]



# UNIQUE COLLECTION



UNIQUE NATIVE 59,7X59,7cm + IRON FIXING KIT  
[BÉTON SMART]

INWOOD FIR 19,7X119cm  
[MATT]



# UNIQUE COLLECTION

## MATT R10A

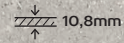

## MATT R10

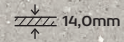

A natural and smooth surface with an incomparable raw touch given by the thin powder used on the double-loading process. Each UNIQUE [Matt] plate is individually designed using a random system that brings the unrepeatability and uniqueness of nature to our day-to-day living.

This product is a completely unglazed porcelain tile suitable for all possible applications, walls and floors, mainly for those with high traffic exposure.

Uma superfície macia e natural com um incomparável toque cru proporcionado pelo finíssimo pó utilizado no processo de duplo carregamento. Cada placa UNIQUE [Mate] é desenhada individualmente usando um sistema aleatório que transporta para o nosso quotidiano o carácter único e singular da natureza.

Como se trata de um produto completamente não esmaltado, em grés porcelânico, é adequado a qualquer tipo de aplicação, revestimento e pavimento, sobretudo para locais onde existe uma grande exposição ao tráfego.

# UNIQUE WHITE

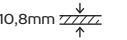

59,7X119cm 24"x47"

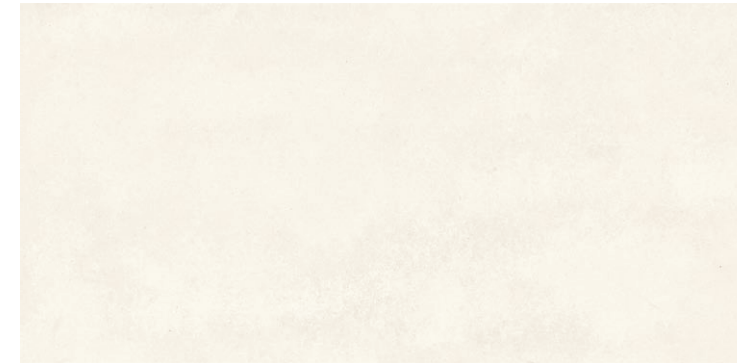

MAT | MATE [R10A] - FM2189MT

59,7X59,7cm 24"x24"



MAT | MATE [R10A] - FM2202MT

89X89cm 35"x35"



MAT | MATE [R10A] - FM2910MT

SKIRTING  
RODAPÉ

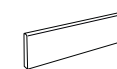

7x59,7cm 3"x24"  
7x89cm 3"x35"

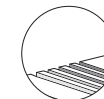

ENHANCED STEPS WITH 5 GROOVES  
DEGRAUS APERFEIÇOADOS COM 5 RASGOS

GROOVED STEP WITH RISER PIECE  
DEGRAU SULCADO COM ESPELHO

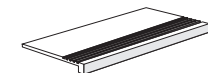

29,7x59,7cm 12"x24"

GROOVED ROUNDED STEP  
DEGRAU BOLEADO SULCADO

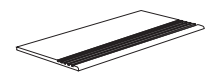

29,7x59,7cm 12"x24"

MONOCALIBER AND FULLY MODULAR FOR ALL SIZES [2mm joint]  
MONOCALIBRE E TOTALMENTE MODULAR PARA TODOS OS FORMATOS [2mm joint]



# UNIQUE NATIVE

10,8mm

59,7X119cm 24"x47"



MAT | MATE [R10A] - FM2191MT

59,7X59,7cm 24"x24"



MAT | MATE [R10A] - FM2201MT

89X89cm 35"x35"



MAT | MATE [R10A] - FM2907MT

14,0mm

59,7X59,7cm 24"x24"



MAT | MATE [R10] - FM3134MT

59,7X119cm 24"x47"



MAT | MATE [R10A] - FM2190MT

89X89cm 35"x35"



MAT | MATE [R10A] - FM2913MT

# UNIQUE BLACK

10,8mm

59,7X59,7cm 24"x24"



MAT | MATE [R10A] - FM2200MT

14,0mm

59,7X59,7cm 24"x24"



MAT | MATE [R10] - FM3135MT

ENHANCED STEPS WITH 5 GROVES  
DEGRAUS APERFEIÇOADOS COM 5 RASGOS

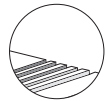

GROOVED ROUNDED STEP  
DEGRAU BOLEADO SULCADO

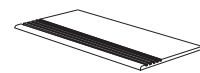

29,7x59,7cm 12"x24"

GROOVED STEP WITH RISER PIECE  
DEGRAU SULCADO COM ESPELHO

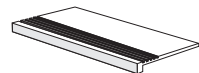

29,7x59,7cm 12"x24"

SKIRTING  
RODAPÉ



7x59,7cm 3"x24"  
7x89cm 3"x35"

MONOCALIBER AND FULLY MODULAR FOR ALL SIZES [2mm joint]  
MONOCALIBRE E TOTALMENTE MODULAR PARA TODOS OS FORMATOS [2mm joint]

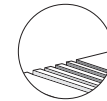

ENHANCED STEPS WITH 5 GROVES  
DEGRAUS APERFEIÇOADOS COM 5 RASGOS

SKIRTING  
RODAPÉ

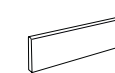

7x59,7cm 3"x24"  
7x89cm 3"x35"

GROOVED STEP WITH RISER PIECE  
DEGRAU SULCADO COM ESPELHO

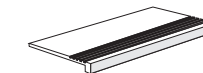

29,7x59,7cm 12"x24"

GROOVED ROUNDED STEP  
DEGRAU BOLEADO SULCADO

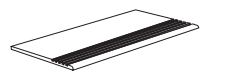

29,7x59,7cm 12"x24"

MONOCALIBER AND FULLY MODULAR FOR ALL SIZES [2mm joint]  
MONOCALIBRE E TOTALMENTE MODULAR PARA TODOS OS FORMATOS [2mm joint]



# UNIQUE COLLECTION

## BÉTON

10,8mm

An amazing surface with an exquisite three dimensional effect that brings concrete imperfections alive. Bubbles, sheens and salt migration spots are the result of the GRT – Grain Repulsion Technology® used on the third loading.

UNIQUE [Béton] is a distinctive product made of unglazed triple-loaded porcelain specially designed to be applied in interior and exterior walls.

It's advisable the use of joints without grout. We recommend at least a 2mm joint.

Uma superfície incrível com um efeito tridimensional único que transmite as verdadeiras imperfeições do betão. Bólbhas, brilhos e manchas de migração de sais, são o resultado da Tecnologia de Repulsão Granulométrica, GRT - Grain Repulsion Technology® utilizada no terceiro carregamento.

UNIQUE [Betão] é um produto muito particular, composto por peças em grés porcelânico não esmaltado, concebido para aplicações de revestimento, tanto interior como exterior.

É aconselhável o uso de junta sem argamassa de selagem. Recomendamos uma junta de pelo menos 2mm.

# UNIQUE WHITE

10,8mm

59,7X119cm 24"X47"



BÉTON | BETÃO FM2193BE

59,7X59,7cm 24"X24"

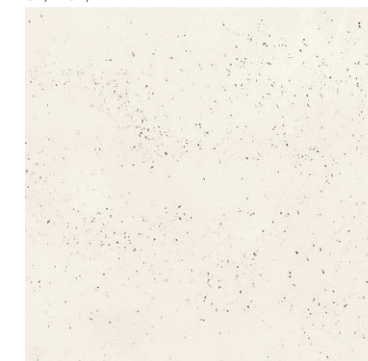

BÉTON | BETÃO FM2269BE

89X89cm 35"X35"



BÉTON | BETÃO FM2911BE



# UNIQUE NATIVE

10,8mm

59,7X119cm 24"X47"



BÉTON | BETÃO FM2194BE

59,7X59,7cm 24"X24"



BÉTON | BETÃO FM2267BE

59,7X119cm 24"X47"



BÉTON | BETÃO FM2198BE

# UNIQUE BLACK

10,8mm

59,7X59,7cm 24"X24"



BÉTON | BETÃO FM2268BE

89X89cm 35"X35"

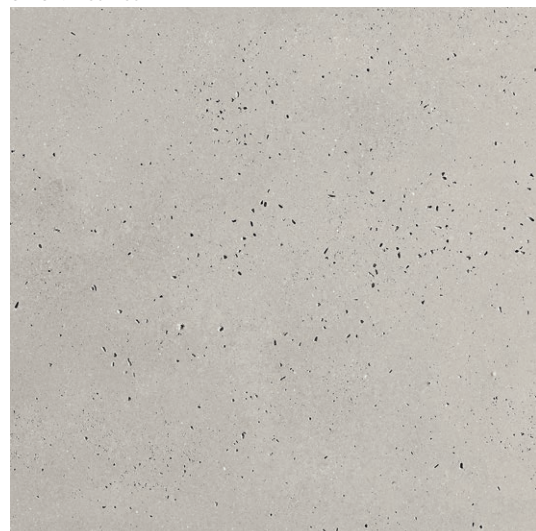

BÉTON | BETÃO FM2908BE

89X89cm 35"X35"



BÉTON | BETÃO FM2914BE



# UNIQUE COLLECTION

## BÉTON SMART

10,8mm

An incomparable surface full of concrete imperfections, bubbles, sheens and salt migration spots, made with the use of GRT - Grain Repulsion Technology®. UNIQUE [Béton Smart] is produced with four milled holes reminding us the concrete formwork performed with wood and hooks by artisans and builders.

UNIQUE [Béton Smart] is a product made of unglazed triple-loaded porcelain designed for interior and exterior wall coverings. It can be supplied with two fixing-kits one in stainless steel and another in iron. It is also possible to be supplied with the same hardware but only for decorative purposes.

It's advisable the use of joints without grout. We recommend at least a 2mm joint.

Uma superfície ímpar, imperfeita como o betão, com bolhas, brilhos e manchas de migração de sais que resultam da utilização da Tecnologia de Repulsão Granulométrica, GRT - Grain Repulsion Technology® utilizada no terceiro carregamento. UNIQUE [Betão Smart] é produzida com quatro furos lembrando-nos a cofragem do betão realizada com madeira e ganchos metálicos, pelos artesãos e construtores.

UNIQUE [Betão Smart] é um produto em grés porcelânico não esmaltado de tripa-carga concebido para revestimento interior e exterior. Pode ser fornecido com dois kits de fixação, ou em ferro. Esse mesmo sistema também está disponível apenas para efeitos decorativos.

É aconselhável o uso de junta sem argamassa de selagem. Recomendamos uma junta de pelo menos 2mm.

# UNIQUE WHITE

10,8mm

59,7X119cm 24"X47"



BÉTON SMART | BETÃO SMART FM2196BS

59,7X59,7cm 24"X24"



BÉTON SMART | BETÃO SMART FM2270BS

89X89cm 35"X35"



BÉTON SMART | BETÃO SMART FM2912BS



# UNIQUE NATIVE

10,8mm

59,7X119cm 24"X47"



BÉTON SMART | BETÃO SMART FM2197BS

59,7X59,7cm 24"X24"



BÉTON SMART | BETÃO SMART FM2271BS

89X89cm 35"X35"

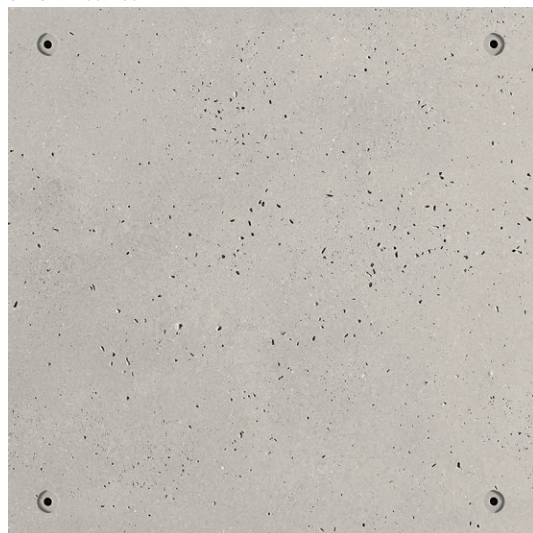

BÉTON SMART | BETÃO SMART FM2909BS

MONOCALIBER AND FULLY MODULAR FOR ALL SIZES [2mm joint]  
MONOCALIBRE E TOTALMENTE MODULAR PARA TODOS OS FORMATOS [2mm joint]

# UNIQUE BLACK

10,8mm

59,7X119cm 24"X47"



BÉTON SMART | BETÃO SMART FM2195BS

59,7X59,7cm 24"X24"

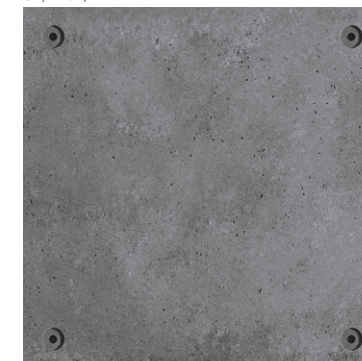

BÉTON SMART | BETÃO SMART FM2272BS

89X89cm 35"X35"

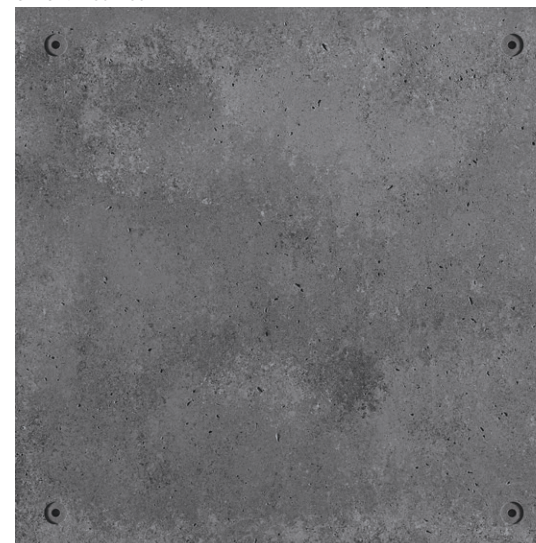

BÉTON SMART | BETÃO SMART FM2915BS

MONOCALIBER AND FULLY MODULAR FOR ALL SIZES [2mm joint]  
MONOCALIBRE E TOTALMENTE MODULAR PARA TODOS OS FORMATOS [2mm joint]



# FIXINGKITS

## STAINLESS STEEL FIXING KIT KIT DE FIXAÇÃO EM AÇO INOX

FMK1

STAINLESS STEEL BOLT CAP | TAMPA DE PARAFUSO EM AÇO INOX

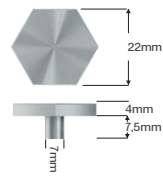

PLASTIC RING | ANILHA EM PLÁSTICO

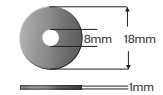

STAINLESS STEEL SCREW | PARAFUSO EM AÇO INOX

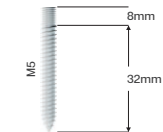

PLASTIC SLEEVE | BUCHA PLÁSTICA

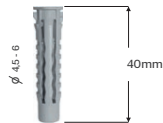

## \* IRON FIXING KIT KIT DE FIXAÇÃO EM FERRO

FMK3

IRON BOLT CAP | TAMPA DE PARAFUSO EM FERRO



\* IT'S NOT ADVISABLE TO INSTALL IRON KITS IN WET AREAS  
NÃO É ACONSELHÁVEL INSTALAR KITS EM FERRO EM ZONAS HÚMIDAS

PLASTIC RING | ANILHA EM PLÁSTICO



STAINLESS STEEL SCREW | PARAFUSO EM AÇO INOX



PLASTIC SLEEVE | BUCHA PLÁSTICA



# DECORATIONKITS

## STAINLESS STEEL DECORATION KIT KIT DE DECORAÇÃO EM AÇO INOX

FMK4

STAINLESS STEEL BOLT CAP | TAMPA DE PARAFUSO EM AÇO INOX

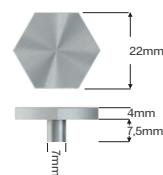

PLASTIC RING | ANILHA EM PLÁSTICO

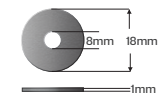

PLASTIC STOPPER | FIXADOR EM PLÁSTICO

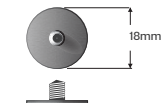

## \* IRON DECORATION KIT KIT DE DECORAÇÃO EM FERRO

FMK2

IRON BOLT CAP | TAMPA DE PARAFUSO EM FERRO



\* IT'S NOT ADVISABLE TO INSTALL IRON KITS IN WET AREAS  
NÃO É ACONSELHÁVEL INSTALAR KITS EM FERRO EM ZONAS HÚMIDAS

PLASTIC RING | ANILHA EM PLÁSTICO



PLASTIC STOPPER | FIXADOR EM PLÁSTICO



# FIXINGHOLE

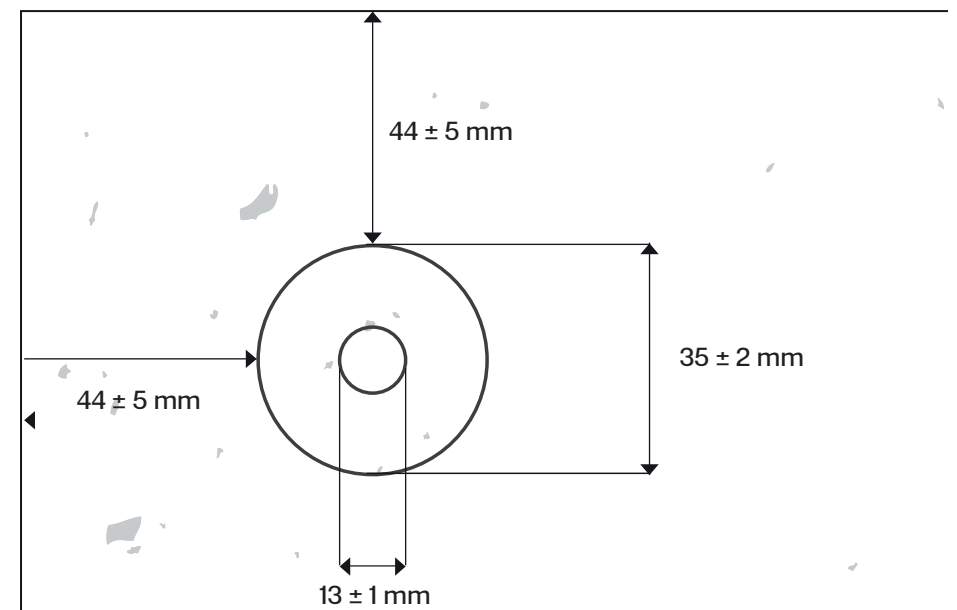
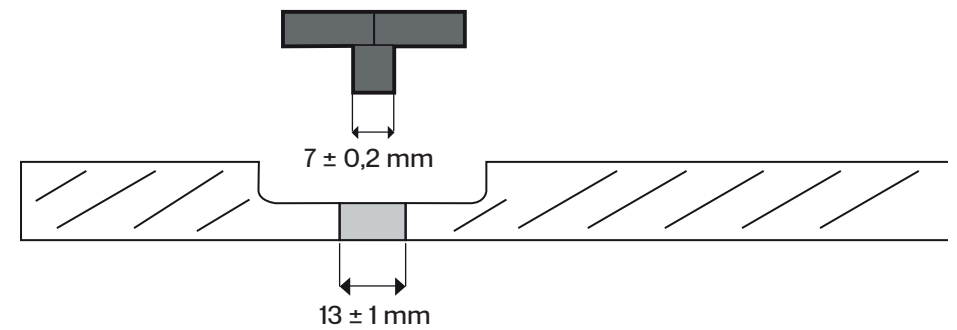
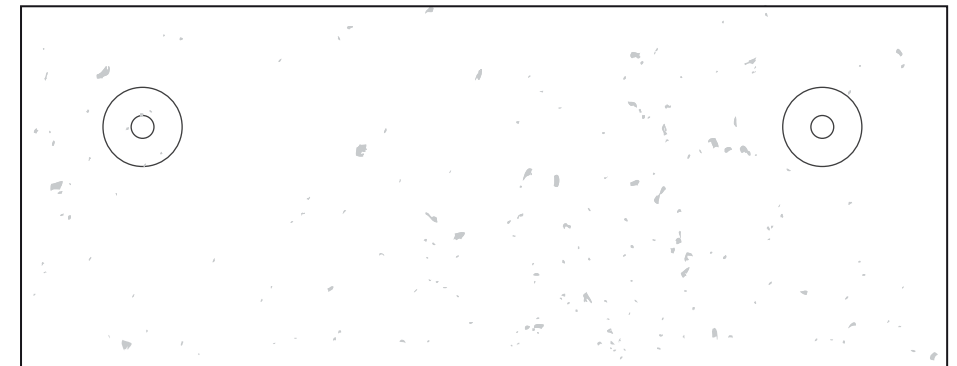



**U** SCRATCH RESISTANCE  
RESISTANCE À L'ABRASION  
RESISTÊNCIA À ABRASÃO

**P** BREAKING STRENGTH  
RÉSISTANCE À LA FLEXION  
RESISTÊNCIA MECÂNICA

**E** BEHAVIOUR IN WATER PRESENCE  
COMPORTEMENT EN PRÉSENCE D'EAU  
COMPORTAMENTO EM PRESENÇA DE ÁGUA

**C** BEHAVIOUR IN PRESENCE OF CHEMICAL PRODUCTS  
COMPORTEMENT EN PRÉSENCE DE PRODUITS CHIMIQUES  
COMPORTAMENTO EM PRESENÇA DE PRODUTOS QUÍMICOS

UPEC
U2
U2S
U3
U3S
U4



## UNIQUE

REFERENCE:	PRODUCT/COLOR:	SIZE:	CLASSIFICATION:
FM2190MT	Unique Black	597x1190x10.8	U4P3E3C2
FM2195BS	Unique Black	597x1190x10.8	U4P3E3C2
FM2198BE	Unique Black	597x1190x10.8	U4P3E3C2
FM2200MT	Unique Black	597x597x10.8	U4P4+E3C2
FM3135MT	Unique Black	597x597x14,0	U4 P4S E3C2
FM2268BE	Unique Black	597x597x10.8	U4P4E3C2
FM2272BS	Unique Black	597x597x10.8	U4P4E3C2
FM2191MT	Unique Native	597x1190x10.8	U4P3E3C2
FM2194BE	Unique Native	597x1190x10.8	U4P3E3C2
FM2197BS	Unique Native	597x1190x10.8	U4P3E3C2
FM2201MT	Unique Native	597x597x10.8	U4P4+E3C2
FM3134MT	Unique Native	597x597x14,0	U4 P4S E3C2
FM2267BE	Unique Native	597x597x10.8	U4P4E3C2
FM2271BS	Unique Native	597x597x10.8	U4P4E3C2
FM2189MT	Unique White	597x1190x10.8	U4P3E3C2
FM2193BE	Unique White	597x1190x10.8	U4P3E3C2
FM2196BS	Unique White	597x1190x10.8	U4P3E3C2
FM2202MT	Unique White	597x597x10.8	U4P4+E3C2
FM2269BE	Unique White	597x597x10.8	U4P4E3C2
FM2270BS	Unique White	597x597x10.8	U4P4E3C2

## MATERIAL

UNGLAZED DOUBLE AND TRIPLE - LOADED PORCELAIN STONEWARE

## PRODUCTION

DOUBLE-LOADING TECHNOLOGY WITH POWDER HOMOGENIZATION AND HIGH GRANULOMETRY REDUCTION ON THE SECOND LAYER [ ≤ 150µm ]  
TRIPLE LOADING WITH GRAIN REPULSION TECHNOLOGY  
HYDRAULIC ISOSTATIC VERTICAL PRESSING [ ≥ 500Kg/cm² ]  
HIGH-SPEED MECHANICAL SHAPING  
SINGLE FIRING WITH EXTRA LONG CYCLE AND HIGH TEMPERATURE [ 1220-1230°C ]  
AUTOMATIC SQUARING AND RECTIFYING OPERATIONS FOR ALL PIECES

# UNIQUE

TECHNICAL FEATURES: DADOS TÉCNICOS:	STANDARDS SPECIFICATIONS VALORES NORMAS	UNIQUE AVERAGE VALUES VALORES MÉDIOS	TEST NORM NORMA DE ENSAIO
EN 14411: ANNEXE G   ANEXO G; GROUP I   GRUPE I   GRUPO BIa			
<b>LENGTH AND WIDTH TOLERANCE</b> DESVIO MÁXIMO PARA COMPRIMENTO E LARGURA	± 0,6%	± 0,3%	
<b>THICKNESS TOLERANCE</b> DESVIO MÁXIMO PARA ESPESSURA	± 5%	± 3%	
<b>STRAIGHTNESS OF SIDES TOLERANCE</b> DESVIO MÁXIMO DA RECTILINEARIDADE	± 0,5%	± 0,3%	ISO 10545-2
<b>RECTANGULARITY TOLERANCE</b> DESVIO MÁXIMO DA ORTOGONALIDADE	± 0,5%	± 0,3%	
<b>FLATNESS TOLERANCE</b> DESVIO MÁXIMO DE PLANARIDADE	± 0,5%	± 0,3%	
<b>WATER ABSORPTION</b> ABSORÇÃO DE ÁGUA	≤ 0,5%	≤ 0,1%	ISO 10545-3
<b>MODULUS OF RUPTURE</b> MÓDULO DE RUPTURA	≥ 35 N/mm²	≥ 45 N/mm² Except/Excepto BE & BS finishing (≥35N/mm²)	ISO 10545-4
<b>BREAKING STRENGTH</b> FORÇA DE RUPTURA	≥ 1300 N	≥ 2500 N Except/Excepto BE & BS finishing (≥2000N)	
<b>DEEP ABRASION RESISTANCE</b> RESISTÊNCIA À ABRASÃO PROFUNDA	≤ 175 mm²	≤ 130 mm²	ISO 10545-6
<b>LINEAR THERMAL EXPANSION</b> DILATAÇÃO TÉRMICA LINEAR	<b>DECLARED VALUE</b> VALOR DECLARADO	≤ 7X10 <sup>-6</sup> / K <sup>-1</sup>	ISO 10545-8
<b>THERMAL SHOCK RESISTANCE</b> RESISTÊNCIA AO CHOQUE TÉRMICO	<b>ORDERED</b> REQUERIDA	<b>RESISTANT</b> RESISTENTE	ISO 10545-9
<b>FROST RESISTANCE</b> RESISTÊNCIA AO GELO	<b>ORDERED</b> REQUERIDA	<b>RESISTANT</b> RESISTENTE	ISO 10545-12
<b>RESISTANCE TO CHEMICALS</b> (ACIDS AND ALKALIS) RESISTÊNCIA AOS QUÍMICOS (ÁCIDOS E BASES)	<b>DECLARED VALUE</b> VALOR DECLARADO	<b>CLASS HA</b> CLASSE HA	ISO 10545-13
<b>RESISTANCE TO CHEMICALS</b> (HOUSEHOLD CHEMICALS & SWIMMING POOL ADDITIVES) RESISTÊNCIA AOS QUÍMICOS (PRODUTOS QUÍMICOS DOMÉSTICOS E ADITIVOS PARA ÁGUA DE PISCINAS)	<b>MINIMUM CLASS B</b> MÍNIMO CLASSE B	<b>CLASS A</b> CLASSE A	
<b>STAIN RESISTANCE</b> RESISTÊNCIA À MANCHA	<b>DECLARED VALUE</b> VALOR DECLARADO	4	ISO 10545-14
	<b>R9</b> 6° - 10°   <b>R10</b> 10° - 19° <b>R11</b> 19° - 27°   <b>R12</b> 27° - 35° <b>R13</b> > 35°	<b>MATT</b> [MT] NATURAL	R9 [14mm] R10 DIN 51130
<b>SLIP RESISTANCE</b> RESISTÊNCIA AO ESCORREGAMENTO	<b>CLASS A</b> ≥ 12°   <b>CLASS B</b> ≥ 18° <b>CLASS C</b> ≥ 24°	<b>MATT</b> [MT] NATURAL	A DIN 51097
		<b>MATT</b> [MT] NATURAL	RD:44 ENV 12633
		<b>MATT</b> [MT] NATURAL	PTV:45 4S BS 7976-2
		<b>MATT</b> [MT] NATURAL	PTV:44 TRL



It is guaranteed the compliance with the values required by the norm EN 14411. Typical value is merely indicative and can differ from real data. | La conformité à la norme EN14411 est garantie. La valeur typique annoncée est purement indicative, pouvant différer des valeurs réelles. | É garantido o cumprimento da norma EN14411. O valor típico anunciado é meramente indicativo, podendo variar dos dados reais.

\*\* test carried out by certified external laboratories whose results are available upon request at our head office. pavigres is willing to check the lot you are interested in purchasing at our own laboratories. the anti-slip performance is guaranteed at the time of delivering the product. | Tests effectués par des laboratoires extérieurs accrédités et à la disposition de toute personne intéressée auprès de nos bureaux. pavigres est disponible pour vérifier dans ses laboratoires un lot qui vous souhaitez acheter. la performance antidérapante est garantie au moment de la livraison du produit. | Testes efetuados por laboratórios exteriores acreditados cujos resultados estão disponíveis na nossa sede sob solicitação. a pavigres está disponível para verificar nos seus laboratórios um lote que pretendam adquirir. a performance antiderrapante é garantida a altura da entrega do produto.

⚠ No claims accepted after ceramic tiles are fixed | Aucune réclamation ne sera acceptée après la pose du carrelage | Não se aceitam reclamações depois do mosaico cerâmico aplicado.





## GRANITY AIR COLLECTION

10 COLORS  
9 SIZES  
4 SURFACES

The Granity Air Collection offers the elegance of natural stone in its purest form.

It is a unique architectural product completely made of unglazed double loaded porcelain. Due to its superb technical performance, the Granity Air Collection is suitable for all possible applications, including very high traffic places.

The Granity Air production begins with the "Dry Colortech" operation. The coloured powder goes through a hyper granulometric reduction process until it reaches a grain diameter of  $150\mu\text{m}$ . This thin powder is homogeneously spread over another layer of non-reduced powder and afterwards both undergo a force of  $500\text{Kg per cm}^2$  carried out by a hydraulic isostatic vertical press.

Tiles are then fired in an extra long cycle at  $1230^\circ\text{C}$  and automatically rectified in order to guarantee monocaliber and full modularity for all sizes.

Composed by nine different sizes, ten colors and four different surfaces all in the same  $10,8\text{mm}$  thickness with the exception of the Polished finish, the Granity Air Collection offers the Architect a wide range of nearly than 360 different porcelain tiles.

A coleção Granity Air oferece-nos a elegância da pedra natural na sua forma mais pura.

Trata-se de uma coleção única, composta por peças de grés porcelânico não esmaltado produzidas com recurso à tecnologia de dupla-carga. Devido às elevadas prestações técnicas e à sua superfície ultra-compacta o produto Granity Air é adequado a qualquer tipo de aplicação, incluindo os espaços de tráfego mais intenso.

A produção da Coleção Granity Air tem início com a coloração a seco, "Dry Colortech". O pó que daí resulta é em seguida submetido a uma operação de hiper redução granulométrica até atingir um diâmetro de  $150\mu\text{m}$ . Esse pó ultrafino é então uniformemente distribuído sobre uma outra camada de pó com granulometria normal, sendo ambos sujeitos a uma força de  $500\text{Kg por cm}^2$  numa operação de prensagem que é levada a cabo com prensas hidráulicas isostáticas verticais.

As peças são posteriormente cozidas com um ciclo extra longo à temperatura de  $1230^\circ\text{C}$  e rectificadas de forma automática, garantindo assim um só calibre e modularidade total para todos os formatos.

Composta por nove formatos, dez cores e quatro acabamentos, e sempre com espessura de  $10,8\text{mm}$  à excepção do acabamento Polido, a Coleção Granity Air oferece uma variedade de quase 360 peças distintas.

GRANITY AIR CREAM 29,7x59,7cm  
[POLISHED]

GRANITY AIR CREAM 59,7x119cm  
[POLISHED]

GRANITY AIR CREAM 59,7x59,7cm  
[MATT RIOA]



# GRANITY AIR SURFACES

POLISHED

9,8mm

MATT R10A

10,8mm

HAMMERED EFFECT R11C

10,8mm

STONE R12C

10,8mm



# GRANITY AIR COLLECTION

## UNVEILING ORIGIN | ART GALLERY

○ GRANITY AIR CREAM 14,7X59,7cm  
[STONE R12C]

○ GRANITY AIR CREAM 59,7X119cm  
[STONE R12C]

GRANITY AIR CREAM 29,7X89cm  
[POLISHED] ○

○ GRANITY AIR CREAM 89X89cm  
[MATT R10A]



# GRANITY AIR COLLECTION



○ GRANITY AIR WHITE 29,7X59,7cm  
[POLISHED]

○ GRANITY AIR CREAM 59,7X119cm  
[POLISHED]



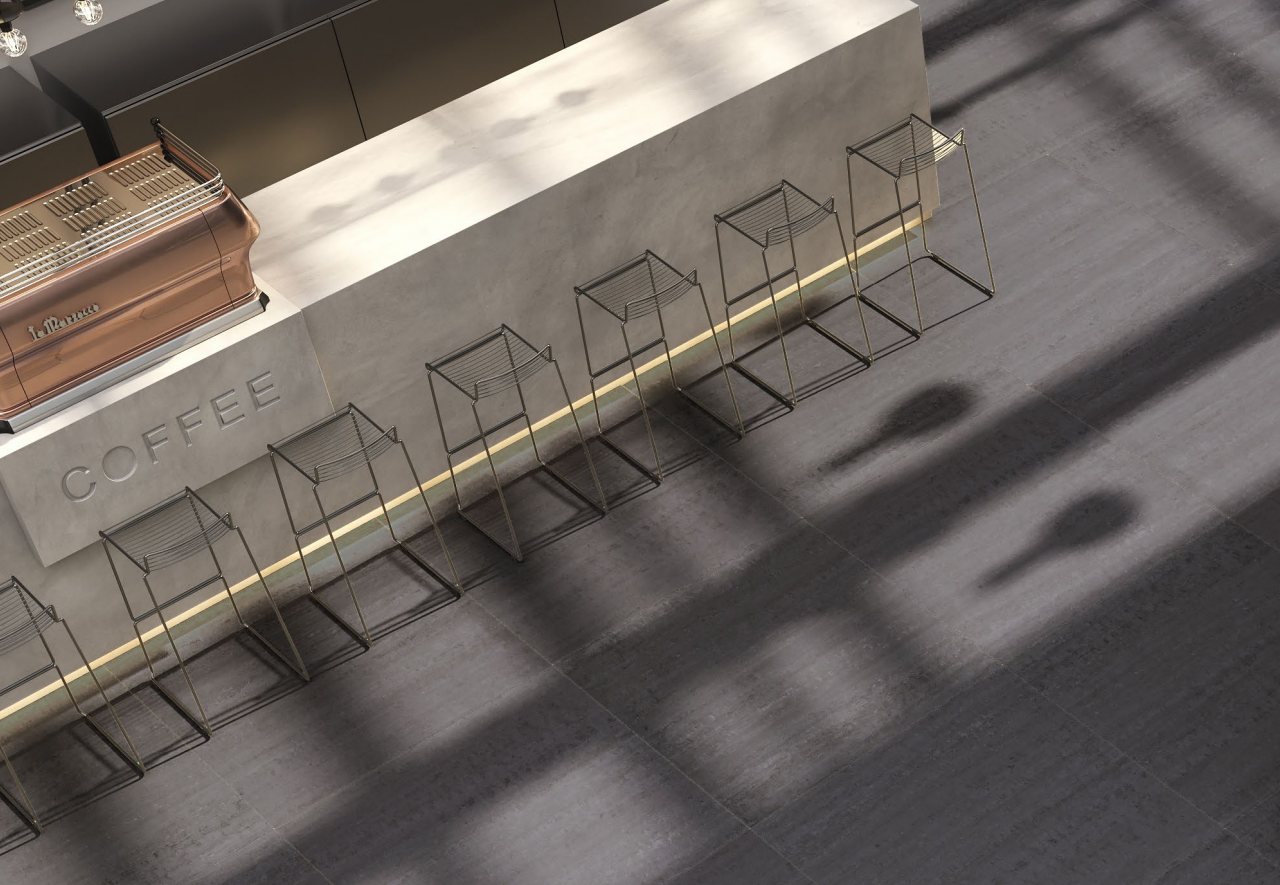

GRANITY AIR COAL 89X89cm  
[MATT RIOA]

BDFM Bros

GRANITY AIR FROST 59,7X59,7cm | 89X89cm  
[POLISHED]

# GRANITY AIR COLLECTION





# GRANITY AIRCOAL

10,8mm

89X89cm 35"X35"



\*\* POLISHED | POLI | POLIDO - FM2929PO  
 MATT | MATE [R10A] - FM808MT  
 HAMMERED EFFECT | BOUCHARDÉ | BUJARDADO [R11C] - FM816EF  
 STONE | PIERRE | PEDRA [R12C] - FM826ST

29,7X89cm 12"X35"



\*\* POLISHED | POLI | POLIDO - FM2924PO  
 MATT | MATE [R10A] - FM2743MT  
 HAMMERED EFFECT | BOUCHARDÉ | BUJARDADO [R11C] - FM2753EF  
 STONE | PIERRE | PEDRA [R12C] - FM2763ST

9,7X9,7cm 4"X4"



AVAILABLE IN MESH

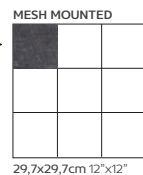

POLISHED | POLI | POLIDO - FM845PO  
 MATT | MATE [R10A] - FM1354MT  
 HAMMERED EFFECT | BOUCHARDÉ | BUJARDADO [R11C] - FM822EF  
 STONE | PIERRE | PEDRA [R12C] - FM832ST

59,7X59,7cm 24"X24"



POLISHED | POLI | POLIDO - FM1373PO  
 MATT | MATE [R10A] - FM1346MT  
 HAMMERED EFFECT | BOUCHARDÉ | BUJARDADO [R11C] - FM1845EF  
 STONE | PIERRE | PEDRA [R12C] - FM1847ST

29,7X59,7cm 12"X24"



POLISHED | POLI | POLIDO - FM1374PO  
 MATT | MATE [R10A] - FM1347MT  
 HAMMERED EFFECT | BOUCHARDÉ | BUJARDADO [R11C] - FM1355EF  
 STONE | PIERRE | PEDRA [R12C] - FM1360ST

14,7X59,7cm 6"X24"

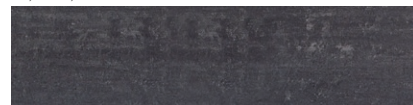

POLISHED | POLI | POLIDO - FM1375PO  
 MATT | MATE [R10A] - FM1348MT  
 HAMMERED EFFECT | BOUCHARDÉ | BUJARDADO [R11C] - FM1356EF  
 STONE | PIERRE | PEDRA [R12C] - FM1361ST

9,7X59,7cm 4"X24"



POLISHED | POLI | POLIDO - FM1376PO  
 MATT | MATE [R10A] - FM1349MT  
 HAMMERED EFFECT | BOUCHARDÉ | BUJARDADO [R11C] - FM1357EF  
 STONE | PIERRE | PEDRA [R12C] - FM1362ST

\*\* FINISHING AVAILABLE UNDER REQUEST  
 \*\* ACABAMENTO DISPONÍVEL SOB CONSULTA

# GRANITY AIRCOAL

10,8mm

59,7X119cm 24"X47"



POLISHED | POLI | POLIDO - FM841PO  
 MATT | MATE [R10A] - FM804MT  
 HAMMERED EFFECT | BOUCHARDÉ | BUJARDADO [R11C] - FM813EF  
 STONE | PIERRE | PEDRA [R12C] - FM823ST

29,7X119cm 12"X47"

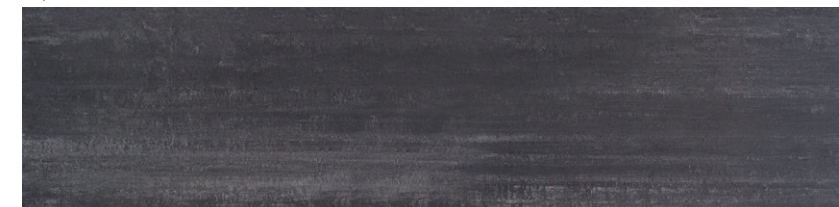

POLISHED | POLI | POLIDO - FM842PO  
 MATT | MATE [R10A] - FM805MT  
 HAMMERED EFFECT | BOUCHARDÉ | BUJARDADO [R11C] - FM814EF  
 STONE | PIERRE | PEDRA [R12C] - FM824ST

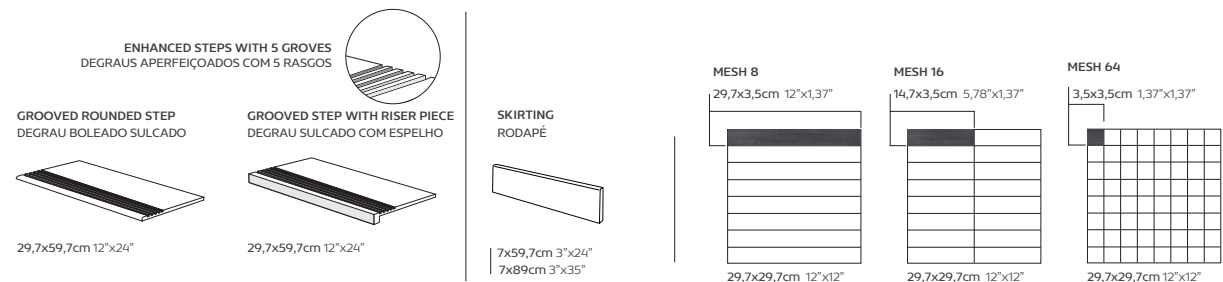

SIZES AVAILABLE UNDER REQUEST  
 FORMATOS DISPONÍVEIS SOB CONSULTA

14,7X119cm 6"X47"



9,7X119cm 4"X47"



4,7X59,7cm 2"X24"



14,7X14,7cm 6"X6"



MONOCALIBER AND FULLY MODULAR FOR ALL SIZES [2mm joint]  
 MONOCALIBRE E TOTALMENTE MODULAR PARA TODOS OS FORMATOS [2mm joint]



# GRANITY AIRSTEEL

10,8mm

89X89cm 35"X35"



\*\* POLISHED | POLI | POLIDO - FM2995PO  
 MATT | MATE [R10A] - FM975MT  
 HAMMERED EFFECT | BOUCHARDÉ | BUJARDADO [R11C] - FM984EF  
 STONE | PIERRE | PEDRA [R12C] - FM992ST

29,7X89cm 12"X35"

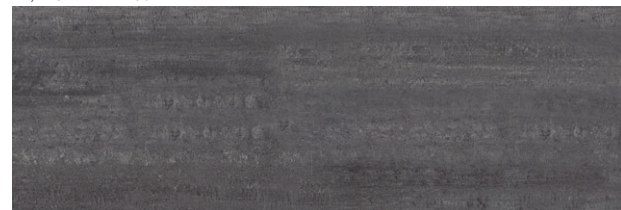

\*\* POLISHED | POLI | POLIDO - FM2996PO  
 MATT | MATE [R10A] - FM2745MT  
 HAMMERED EFFECT | BOUCHARDÉ | BUJARDADO [R11C] - FM2755EF  
 STONE | PIERRE | PEDRA [R12C] - FM2765ST

9,7X9,7cm 4"X4"



POLISHED | POLI | POLIDO - FM1535PO  
 MATT | MATE [R10A] - FM1506MT  
 HAMMERED EFFECT | BOUCHARDÉ | BUJARDADO [R11C] - FM1511EF  
 STONE | PIERRE | PEDRA [R12C] - FM1519ST

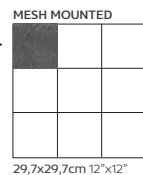

59,7X59,7cm 24"X24"



POLISHED | POLI | POLIDO - FM1528PO  
 MATT | MATE [R10A] - FM1498MT  
 HAMMERED EFFECT | BOUCHARDÉ | BUJARDADO [R11C] - FM1507EF  
 STONE | PIERRE | PEDRA [R12C] - FM1512ST

29,7X59,7cm 12"X24"



POLISHED | POLI | POLIDO - FM1529PO  
 MATT | MATE [R10A] - FM1499MT  
 HAMMERED EFFECT | BOUCHARDÉ | BUJARDADO [R11C] - FM1508EF  
 STONE | PIERRE | PEDRA [R12C] - FM1513ST

14,7X59,7cm 6"X24"



POLISHED | POLI | POLIDO - FM1530PO  
 MATT | MATE [R10A] - FM1500MT  
 HAMMERED EFFECT | BOUCHARDÉ | BUJARDADO [R11C] - FM986EF  
 STONE | PIERRE | PEDRA [R12C] - FM1514ST

9,7X59,7cm 4"X24"



POLISHED | POLI | POLIDO - FM1531PO  
 MATT | MATE [R10A] - FM1501MT  
 HAMMERED EFFECT | BOUCHARDÉ | BUJARDADO [R11C] - FM2675EF  
 STONE | PIERRE | PEDRA [R12C] - FM1515ST

\*\* FINISHING AVAILABLE UNDER REQUEST  
 \*\* ACABAMENTO DISPONÍVEL SOB CONSULTA

# GRANITY AIRSTEEL

10,8mm

59,7X119cm 24"X47"



POLISHED | POLI | POLIDO - FM1002PO  
 MATT | MATE [R10A] - FM971MT  
 HAMMERED EFFECT | BOUCHARDÉ | BUJARDADO [R11C] - FM980EF  
 STONE | PIERRE | PEDRA [R12C] - FM988ST

29,7X119cm 12"X47"



POLISHED | POLI | POLIDO - FM1003PO  
 MATT | MATE [R10A] - FM972MT  
 HAMMERED EFFECT | BOUCHARDÉ | BUJARDADO [R11C] - FM981EF  
 STONE | PIERRE | PEDRA [R12C] - FM989ST

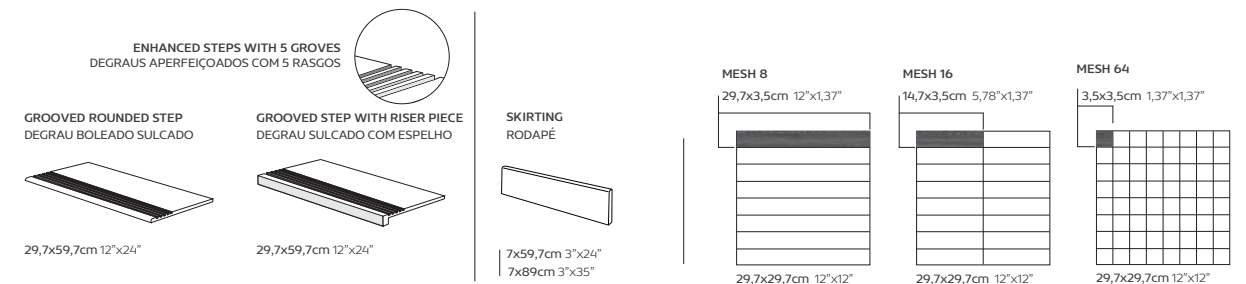

SIZES AVAILABLE UNDER REQUEST  
 FORMATOS DISPONÍVEIS SOB CONSULTA

14,7X119cm 6"X47"



9,7X119cm 4"X47"



4,7X59,7cm 2"X24"



14,7X14,7cm 6"X6"



MONOCALIBER AND FULLY MODULAR FOR ALL SIZES [2mm joint]  
 MONOCALIBRE E TOTALMENTE MODULAR PARA TODOS OS FORMATOS [2mm joint]



# GRANITY AIRSILVER

10,8mm

89X89cm 35"X35"

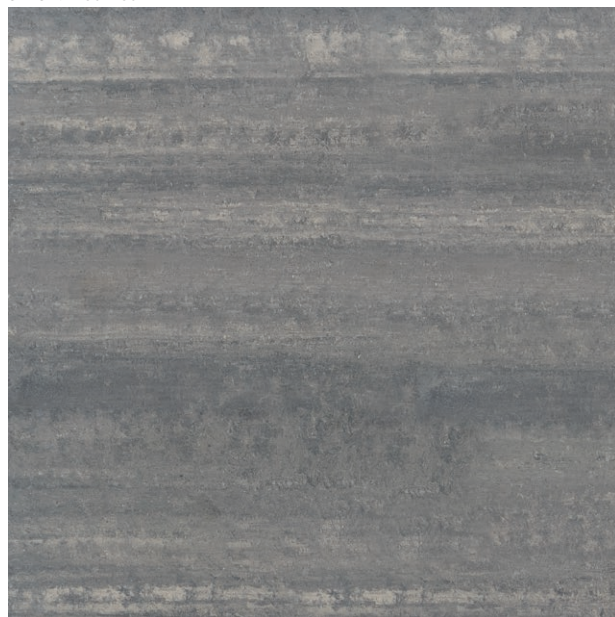

\*\* POLISHED | POLI | POLIDO - FM2990PO  
 MATT | MATE [R10A] - FM935MT  
 HAMMERED EFFECT | BOUCHARDÉ | BUJARDADO [R11C] - FM944EF  
 STONE | PIERRE | PEDRA [R12C] - FM952ST

29,7X89cm 12"X35"



\*\* POLISHED | POLI | POLIDO - FM2997PO  
 MATT | MATE [R10A] - FM2263MT  
 HAMMERED EFFECT | BOUCHARDÉ | BUJARDADO [R11C] - FM2751EF  
 STONE | PIERRE | PEDRA [R12C] - FM2761ST

9,7X9,7cm 4"X4"



POLISHED | POLI | POLIDO - FM970PO  
 MATT | MATE [R10A] - FM1473MT  
 HAMMERED EFFECT | BOUCHARDÉ | BUJARDADO [R11C] - FM948EF  
 STONE | PIERRE | PEDRA [R12C] - FM956ST

AVAILABLE IN MESH

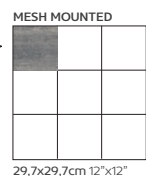

59,7X59,7cm 24"X24"



POLISHED | POLI | POLIDO - FM1492PO  
 MATT | MATE [R10A] - FM1466MT  
 HAMMERED EFFECT | BOUCHARDÉ | BUJARDADO [R11C] - FM1844EF  
 STONE | PIERRE | PEDRA [R12C] - FM1479ST

29,7X59,7cm 12"X24"

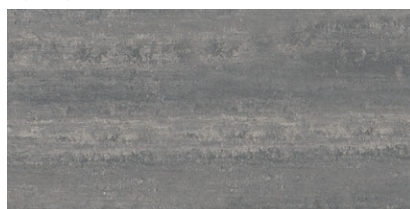

POLISHED | POLI | POLIDO - FM1493PO  
 MATT | MATE [R10A] - FM1467MT  
 HAMMERED EFFECT | BOUCHARDÉ | BUJARDADO [R11C] - FM1474EF  
 STONE | PIERRE | PEDRA [R12C] - FM1480ST

14,7X59,7cm 6"X24"



POLISHED | POLI | POLIDO - FM1494PO  
 MATT | MATE [R10A] - FM1468MT  
 HAMMERED EFFECT | BOUCHARDÉ | BUJARDADO [R11C] - FM1475EF  
 STONE | PIERRE | PEDRA [R12C] - FM1481ST

9,7X59,7cm 4"X24"



POLISHED | POLI | POLIDO - FM1495PO  
 MATT | MATE [R10A] - FM1469MT  
 HAMMERED EFFECT | BOUCHARDÉ | BUJARDADO [R11C] - FM1476EF  
 STONE | PIERRE | PEDRA [R12C] - FM1482ST

\*\* FINISHING AVAILABLE UNDER REQUEST  
 \*\* ACABAMENTO DISPONÍVEL SOB CONSULTA

# GRANITY AIRSILVER

10,8mm

59,7X119cm 24"X47"

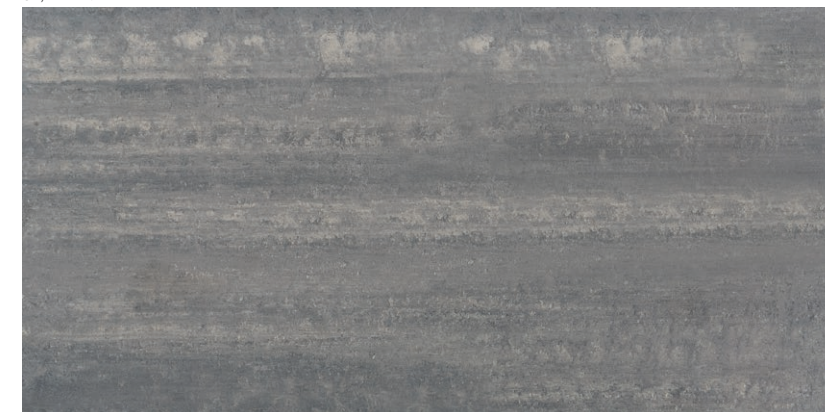

POLISHED | POLI | POLIDO - FM965PO  
 MATT | MATE [R10A] - FM931MT  
 HAMMERED EFFECT | BOUCHARDÉ | BUJARDADO [R11C] - FM941EF  
 STONE | PIERRE | PEDRA [R12C] - FM949ST

29,7X119cm 12"X47"



POLISHED | POLI | POLIDO - FM966PO  
 MATT | MATE [R10A] - FM932MT  
 HAMMERED EFFECT | BOUCHARDÉ | BUJARDADO [R11C] - FM942EF  
 STONE | PIERRE | PEDRA [R12C] - FM950ST

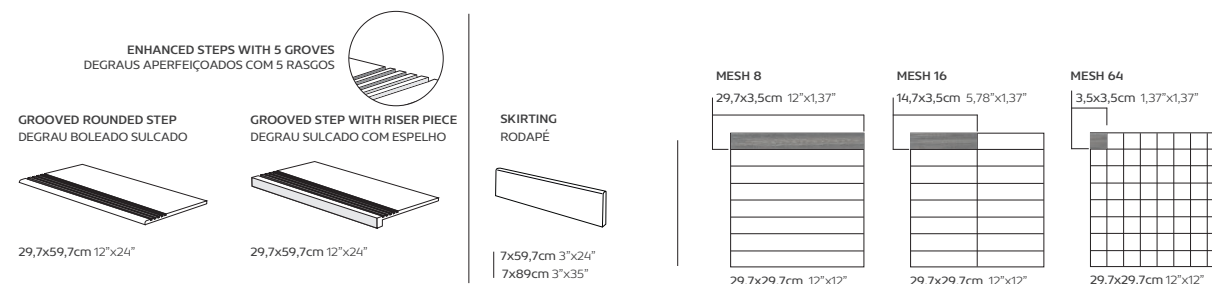

SIZES AVAILABLE UNDER REQUEST  
 FORMATOS DISPONÍVEIS SOB CONSULTA

14,7X119cm 6"X47"



9,7X119cm 4"X47"



4,7X59,7cm 2"X24"



14,7X14,7cm 6"X6"

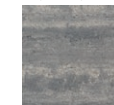

MONOCALIBER AND FULLY MODULAR FOR ALL SIZES [2mm joint]  
 MONOCALIBRE E TOTALMENTE MODULAR PARA TODOS OS FORMATOS [2mm joint]



# GRANITY AIR FROST

10,8mm

89X89cm 35"X35"



\*\* POLISHED | POLI | POLIDO - FM2931PO  
 MATT | MATE [R10A] - FM1188MT  
 HAMMERED EFFECT | BOUCHARDÉ | BUJARDADO [R11C] - FM1198EF  
 STONE | PIERRE | PEDRA [R12C] - FM1209ST

29,7X89cm 12"X35"



\*\* POLISHED | POLI | POLIDO - FM2926PO  
 MATT | MATE [R10A] - FM2744MT  
 HAMMERED EFFECT | BOUCHARDÉ | BUJARDADO [R11C] - FM2754EF  
 STONE | PIERRE | PEDRA [R12C] - FM2764ST

9,7X9,7cm 4"X4"



AVAILABLE IN MESH

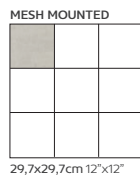

29,7x29,7cm 12"x12"

POLISHED | POLI | POLIDO - FM1226PO  
 MATT | MATE [R10A] - FM1194MT  
 HAMMERED EFFECT | BOUCHARDÉ | BUJARDADO [R11C] - FM1204EF  
 STONE | PIERRE | PEDRA [R12C] - FM1212ST

59,7X59,7cm 24"X24"



POLISHED | POLI | POLIDO - FM1732PO  
 MATT | MATE [R10A] - FM1708MT  
 HAMMERED EFFECT | BOUCHARDÉ | BUJARDADO [R11C] - FM1715EF  
 STONE | PIERRE | PEDRA [R12C] - FM1720ST

29,7X59,7cm 12"X24"

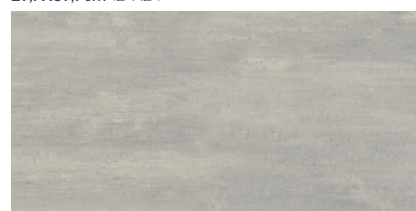

POLISHED | POLI | POLIDO - FM1733PO  
 MATT | MATE [R10A] - FM1709MT  
 HAMMERED EFFECT | BOUCHARDÉ | BUJARDADO [R11C] - FM1716EF  
 STONE | PIERRE | PEDRA [R12C] - FM1721ST

14,7X59,7cm 6"X24"



POLISHED | POLI | POLIDO - FM1734PO  
 MATT | MATE [R10A] - FM1710MT  
 HAMMERED EFFECT | BOUCHARDÉ | BUJARDADO [R11C] - FM1201EF  
 STONE | PIERRE | PEDRA [R12C] - FM1722ST

9,7X59,7cm 4"X24"

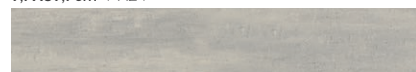

POLISHED | POLI | POLIDO - FM1735PO  
 MATT | MATE [R10A] - FM1711MT  
 HAMMERED EFFECT | BOUCHARDÉ | BUJARDADO [R11C] - FM1717EF  
 STONE | PIERRE | PEDRA [R12C] - FM1723ST

\*\* FINISHING AVAILABLE UNDER REQUEST  
 \*\* ACABAMENTO DISPONÍVEL SOB CONSULTA

# GRANITY AIR FROST

10,8mm

59,7X119cm 24"X47"



POLISHED | POLI | POLIDO - FM1223PO  
 MATT | MATE [R10A] - FM1184MT  
 HAMMERED EFFECT | BOUCHARDÉ | BUJARDADO [R11C] - FM1195EF  
 STONE | PIERRE | PEDRA [R12C] - FM1205ST

29,7X119cm 12"X47"



POLISHED | POLI | POLIDO - FM2789PO  
 MATT | MATE [R10A] - FM1185MT  
 HAMMERED EFFECT | BOUCHARDÉ | BUJARDADO [R11C] - FM1196EF  
 STONE | PIERRE | PEDRA [R12C] - FM1206ST

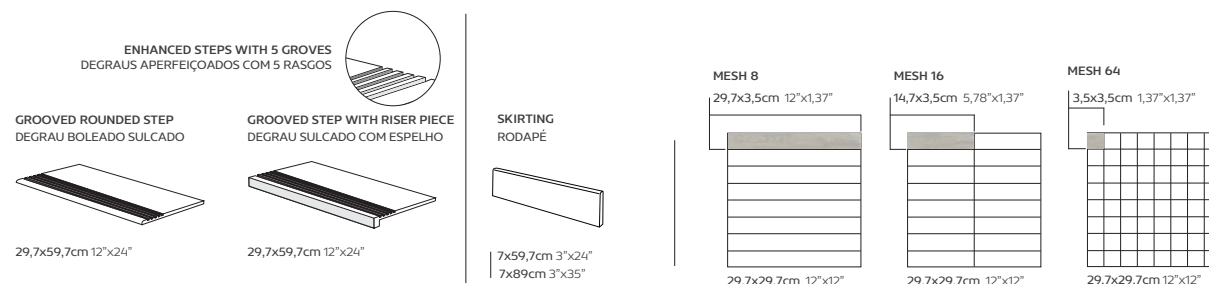

SIZES AVAILABLE UNDER REQUEST  
 FORMATOS DISPONÍVEIS SOB CONSULTA

14,7X119cm 6"X47"



9,7X119cm 4"X47"



4,7X59,7cm 2"X24"



14,7X14,7cm 6"X6"



MONOCALIBRE AND FULLY MODULAR FOR ALL SIZES [2mm joint]  
 MONOCALIBRE E TOTALMENTE MODULAR PARA TODOS OS FORMATOS [2mm joint]



# GRANITY AIR COLLECTION



○ GRANITY AIR FROST 59,7X29,7cm  
[MATT R10A]

○ GRANITY AIR FROST 59,7X29,7cm  
[POLISHED]

○ GRANITY AIR SILVER 59,7X59,7cm  
[MATT R10A]



# GRANITY AIR ARTIC

10,8mm

89X89cm 35"X35"

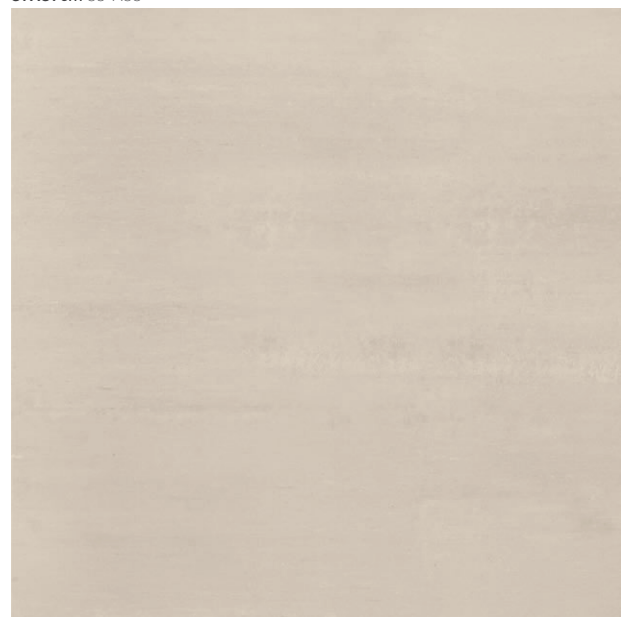

\*\* POLISHED | POLI | POLIDO - FM2998PO  
 MATT | MATE [R10A] - FM1114MT  
 HAMMERED EFFECT | BOUCHARDÉ | BUJARDADO [R11C] - FM1121EF  
 STONE | PIERRE | PEDRA [R12C] - FM1131ST

29,7X89cm 12"X35"



\*\* POLISHED | POLI | POLIDO - FM2999PO  
 MATT | MATE [R10A] - FM2742MT  
 HAMMERED EFFECT | BOUCHARDÉ | BUJARDADO [R11C] - FM2752EF  
 STONE | PIERRE | PEDRA [R12C] - FM2762ST

9,7X9,7cm 4"X4"



AVAILABLE IN MESH

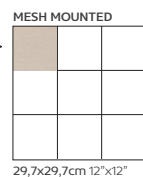

29,7x29,7cm 12"x12"

POLISHED | POLI | POLIDO - FM1147PO  
 MATT | MATE [R10A] - FM1651MT  
 HAMMERED EFFECT | BOUCHARDÉ | BUJARDADO [R11C] - FM1128EF  
 STONE | PIERRE | PEDRA [R12C] - FM1134ST

59,7X59,7cm 24"X24"



POLISHED | POLI | POLIDO - FM1668PO  
 MATT | MATE [R10A] - FM1644MT  
 HAMMERED EFFECT | BOUCHARDÉ | BUJARDADO [R11C] - FM1652EF  
 STONE | PIERRE | PEDRA [R12C] - FM1655ST

29,7X59,7cm 12"X24"



POLISHED | POLI | POLIDO - FM1669PO  
 MATT | MATE [R10A] - FM1645MT  
 HAMMERED EFFECT | BOUCHARDÉ | BUJARDADO [R11C] - FM1653EF  
 STONE | PIERRE | PEDRA [R12C] - FM1656ST

14,7X59,7cm 6"X24"



POLISHED | POLI | POLIDO - FM1670PO  
 MATT | MATE [R10A] - FM1646MT  
 HAMMERED EFFECT | BOUCHARDÉ | BUJARDADO [R11C] - FM1123EF  
 STONE | PIERRE | PEDRA [R12C] - FM1657ST

9,7X59,7cm 4"X24"

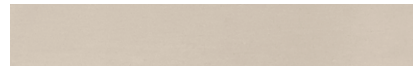

POLISHED | POLI | POLIDO - FM1671PO  
 MATT | MATE [R10A] - FM1647MT  
 HAMMERED EFFECT | BOUCHARDÉ | BUJARDADO [R11C] - FM1124EF  
 STONE | PIERRE | PEDRA [R12C] - FM1658ST

\*\* FINISHING AVAILABLE UNDER REQUEST  
 \*\* ACABAMENTO DISPONÍVEL SOB CONSULTA

# GRANITY AIR ARTIC

10,8mm

59,7X119cm 24"X47"



POLISHED | POLI | POLIDO - FM1141PO  
 MATT | MATE [R10A] - FM1111MT  
 HAMMERED EFFECT | BOUCHARDÉ | BUJARDADO [R11C] - FM1119EF  
 STONE | PIERRE | PEDRA [R12C] - FM1129ST

29,7X119cm 12"X47"



POLISHED | POLI | POLIDO - FM1142PO  
 MATT | MATE [R10A] - FM1112MT  
 HAMMERED EFFECT | BOUCHARDÉ | BUJARDADO [R11C] - FM1120EF  
 STONE | PIERRE | PEDRA [R12C] - FM1130ST

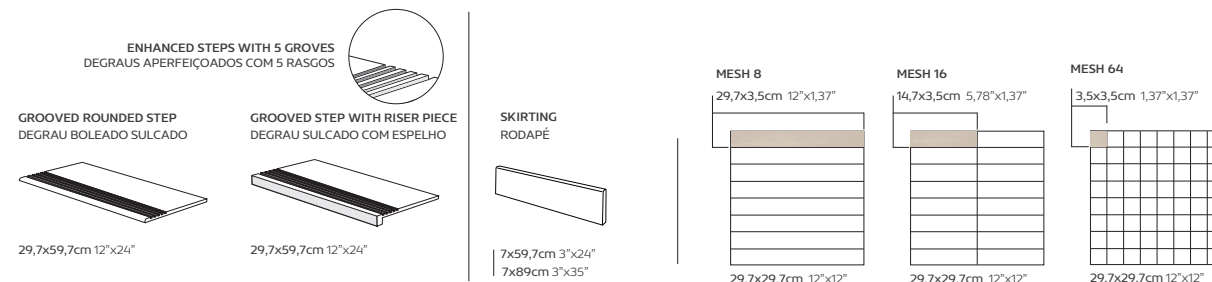

SIZES AVAILABLE UNDER REQUEST  
 FORMATOS DISPONÍVEIS SOB CONSULTA

14,7X119cm 6"X47"



9,7X119cm 4"X47"



4,7X59,7cm 2"X24"

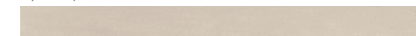

14,7X14,7cm 6"X6"



MONOCALIBER AND FULLY MODULAR FOR ALL SIZES [2mm joint]  
 MONOCALIBRE E TOTALMENTE MODULAR PARA TODOS OS FORMATOS [2mm joint]



# GRANITY AIR<sup>WHITE</sup>

10,8mm

89X89cm 35"X35"



\*\* POLISHED | POLI | POLIDO - FM3000PO  
 MATT | MATE [R10A] - FM2597MT  
 HAMMERED EFFECT | BOUCHARDÉ | BUJARDADO [R11C] - FM2599EF  
 STONE | PIERRE | PEDRA [R12C] - FM2598ST

29,7X89cm 12"X35"



\*\* POLISHED | POLI | POLIDO - FM2920PO  
 MATT | MATE [R10A] - FM2746MT  
 HAMMERED EFFECT | BOUCHARDÉ | BUJARDADO [R11C] - FM2756EF  
 STONE | PIERRE | PEDRA [R12C] - FM2766ST

9,7X9,7cm 4"X4"



AVAILABLE IN MESH

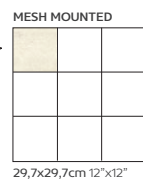

29,7x29,7cm 12"x12"

POLISHED | POLI | POLIDO - FM2654PO  
 MATT | MATE [R10A] - FM2644MT  
 HAMMERED EFFECT | BOUCHARDÉ | BUJARDADO [R11C] - FM2639EF  
 STONE | PIERRE | PEDRA [R12C] - FM2649ST

59,7X59,7cm 24"X24"



POLISHED | POLI | POLIDO - FM2622PO  
 MATT | MATE [R10A] - FM2621MT  
 HAMMERED EFFECT | BOUCHARDÉ | BUJARDADO [R11C] - FM2736EF  
 STONE | PIERRE | PEDRA [R12C] - FM2737ST

29,7X59,7cm 12"X24"



POLISHED | POLI | POLIDO - FM2735PO  
 MATT | MATE [R10A] - FM2725MT  
 HAMMERED EFFECT | BOUCHARDÉ | BUJARDADO [R11C] - FM2720EF  
 STONE | PIERRE | PEDRA [R12C] - FM2730ST

14,7X59,7cm 6"X24"

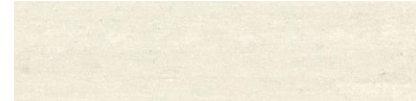

POLISHED | POLI | POLIDO - FM2715PO  
 MATT | MATE [R10A] - FM2705MT  
 HAMMERED EFFECT | BOUCHARDÉ | BUJARDADO [R11C] - FM2700EF  
 STONE | PIERRE | PEDRA [R12C] - FM2710ST

9,7X59,7cm 4"X24"



POLISHED | POLI | POLIDO - FM2695PO  
 MATT | MATE [R10A] - FM2685MT  
 HAMMERED EFFECT | BOUCHARDÉ | BUJARDADO [R11C] - FM2680EF  
 STONE | PIERRE | PEDRA [R12C] - FM2690ST

\*\* FINISHING AVAILABLE UNDER REQUEST  
 \*\* ACABAMENTO DISPONÍVEL SOB CONSULTA

# GRANITY AIR<sup>WHITE</sup>

10,8mm

59,7X119cm 24"X47"



POLISHED | POLI | POLIDO - FM2802PO  
 MATT | MATE [R10A] - FM2796MT  
 HAMMERED EFFECT | BOUCHARDÉ | BUJARDADO [R11C] - FM2795EF  
 STONE | PIERRE | PEDRA [R12C] - FM2797ST

29,7X119cm 12"X47"



POLISHED | POLI | POLIDO - FM2791PO  
 MATT | MATE [R10A] - FM2780MT  
 HAMMERED EFFECT | BOUCHARDÉ | BUJARDADO [R11C] - FM2775EF  
 STONE | PIERRE | PEDRA [R12C] - FM2785ST

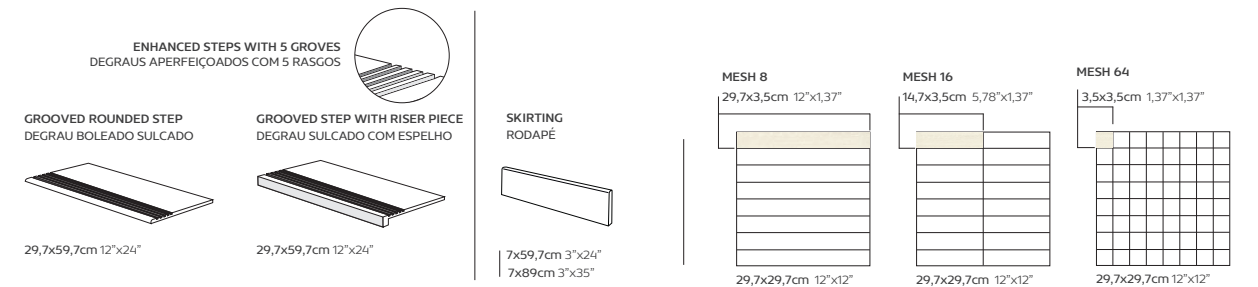

SIZES AVAILABLE UNDER REQUEST  
 FORMATOS DISPONÍVEIS SOB CONSULTA

14,7X119cm 6"X47"



9,7X119cm 4"X47"



4,7X59,7cm 2"X24"



14,7X14,7cm 6"X6"

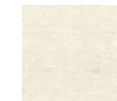

MONOCALIBER AND FULLY MODULAR FOR ALL SIZES [2mm joint]  
 MONOCALIBRE E TOTALMENTE MODULAR PARA TODOS OS FORMATOS [2mm joint]



# GRANITY AIR BEIGE

10,8mm

89X89cm 35"X35"



\*\* POLISHED | POLI | POLIDO - FM3001PO  
 MATT | MATE [R10A] - FM2624MT  
 HAMMERED EFFECT | BOUCHARDÉ | BUJARDADO [R11C] - FM2625EF  
 STONE | PIERRE | PEDRA [R12C] - FM2626ST

29,7X89cm 12"X35"



\*\* POLISHED | POLI | POLIDO - FM3002PO  
 MATT | MATE [R10A] - FM2747MT  
 HAMMERED EFFECT | BOUCHARDÉ | BUJARDADO [R11C] - FM2757EF  
 STONE | PIERRE | PEDRA [R12C] - FM2767ST

9,7X9,7cm 4"X4"



AVAILABLE IN MESH

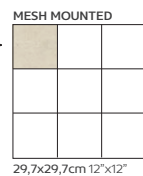

POLISHED | POLI | POLIDO - FM2650PO  
 MATT | MATE [R10A] - FM2640MT  
 HAMMERED EFFECT | BOUCHARDÉ | BUJARDADO [R11C] - FM2635EF  
 STONE | PIERRE | PEDRA [R12C] - FM2645ST

59,7X59,7cm 24"X24"



POLISHED | POLI | POLIDO - FM2738PO  
 MATT | MATE [R10A] - FM2589MT  
 HAMMERED EFFECT | BOUCHARDÉ | BUJARDADO [R11C] - FM2595EF  
 STONE | PIERRE | PEDRA [R12C] - FM2592ST

29,7X59,7cm 12"X24"



POLISHED | POLI | POLIDO - FM2731PO  
 MATT | MATE [R10A] - FM2721MT  
 HAMMERED EFFECT | BOUCHARDÉ | BUJARDADO [R11C] - FM2716EF  
 STONE | PIERRE | PEDRA [R12C] - FM2726ST

14,7X59,7cm 6"X24"

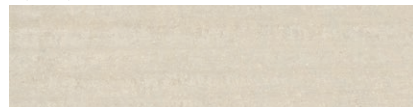

POLISHED | POLI | POLIDO - FM2711PO  
 MATT | MATE [R10A] - FM2701MT  
 HAMMERED EFFECT | BOUCHARDÉ | BUJARDADO [R11C] - FM2696EF  
 STONE | PIERRE | PEDRA [R12C] - FM2706ST

9,7X59,7cm 4"X24"



POLISHED | POLI | POLIDO - FM2691PO  
 MATT | MATE [R10A] - FM2681MT  
 HAMMERED EFFECT | BOUCHARDÉ | BUJARDADO [R11C] - FM2676EF  
 STONE | PIERRE | PEDRA [R12C] - FM2686ST

\*\* FINISHING AVAILABLE UNDER REQUEST  
 \*\* ACABAMENTO DISPONÍVEL SOB CONSULTA

# GRANITY AIR BEIGE

10,8mm

59,7X119cm 24"X47"

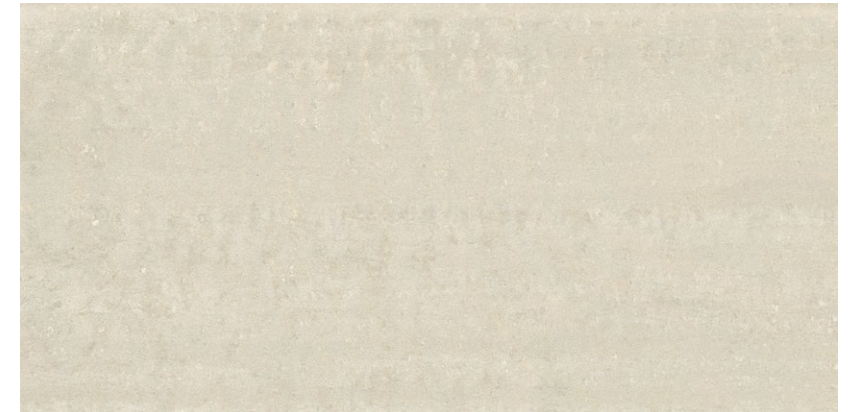

POLISHED | POLI | POLIDO - FM2798PO  
 MATT | MATE [R10A] - FM2615MT  
 HAMMERED EFFECT | BOUCHARDÉ | BUJARDADO [R11C] - FM2610EF  
 STONE | PIERRE | PEDRA [R12C] - FM2612ST

29,7X119cm 12"X47"



POLISHED | POLI | POLIDO - FM2790PO  
 MATT | MATE [R10A] - FM2779MT  
 HAMMERED EFFECT | BOUCHARDÉ | BUJARDADO [R11C] - FM2774EF  
 STONE | PIERRE | PEDRA [R12C] - FM2784ST

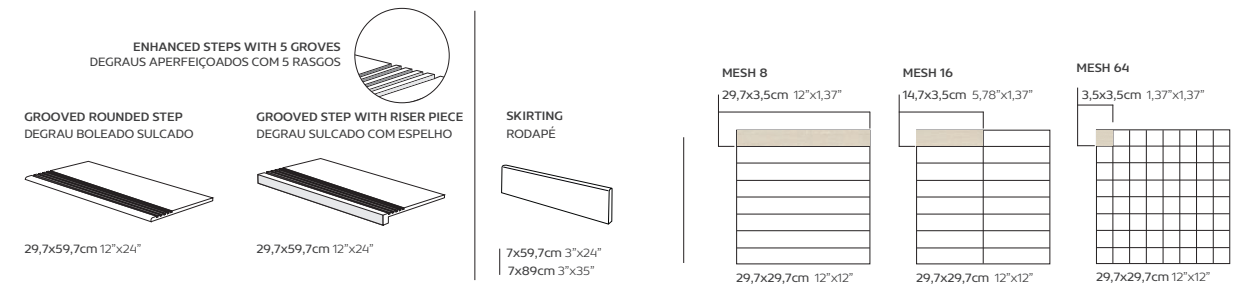

SIZES AVAILABLE UNDER REQUEST  
 FORMATOS DISPONÍVEIS SOB CONSULTA

14,7X119cm 6"X47"

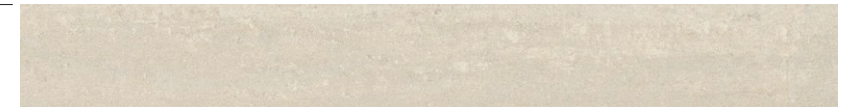

9,7X119cm 4"X47"

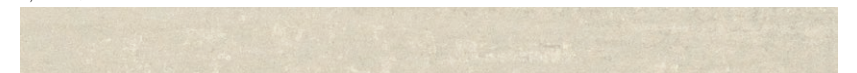

4,7X59,7cm 2"X24"



14,7X14,7cm 6"X6"



MONOCALIBER AND FULLY MODULAR FOR ALL SIZES [2mm joint]  
 MONOCALIBRE E TOTALMENTE MODULAR PARA TODOS OS FORMATOS [2mm joint]



# GRANITY AIRCREAM

10,8mm

89X89cm 35"X35"



\*\* POLISHED | POLI | POLIDO - FM3478PO  
 MATT | MATE [R10A] - FM3479MT  
 HAMMERED EFFECT | BOUCHARDÉ | BUJARDADO [R11C] - FM3480EF  
 STONE | PIERRE | PEDRA [R12C] - FM3481ST

29,7X89cm 12"X35"



\*\* POLISHED | POLI | POLIDO - FM3490PO  
 MATT | MATE [R10A] - FM3491MT  
 HAMMERED EFFECT | BOUCHARDÉ | BUJARDADO [R11C] - FM3492EF  
 STONE | PIERRE | PEDRA [R12C] - FM3493ST

9,7X9,7cm 4"X4"



AVAILABLE IN MESH

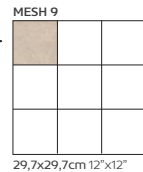

POLISHED | POLI | POLIDO - FM3506PO  
 MATT | MATE [R10A] - FM3507MT  
 HAMMERED EFFECT | BOUCHARDÉ | BUJARDADO [R11C] - FM3508EF  
 STONE | PIERRE | PEDRA [R12C] - FM3509ST

59,7X59,7cm 24"X24"



POLISHED | POLI | POLIDO - FM3482PO  
 MATT | MATE [R10A] - FM3483MT  
 HAMMERED EFFECT | BOUCHARDÉ | BUJARDADO [R11C] - FM3484EF  
 STONE | PIERRE | PEDRA [R12C] - FM3485ST

29,7X59,7cm 12"X24"



POLISHED | POLI | POLIDO - FM3486PO  
 MATT | MATE [R10A] - FM3487MT  
 HAMMERED EFFECT | BOUCHARDÉ | BUJARDADO [R11C] - FM3488EF  
 STONE | PIERRE | PEDRA [R12C] - FM3489ST

14,7X59,7cm 6"X24"

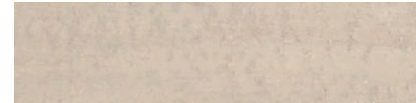

POLISHED | POLI | POLIDO - FM3498PO  
 MATT | MATE [R10A] - FM3499MT  
 HAMMERED EFFECT | BOUCHARDÉ | BUJARDADO [R11C] - FM3500EF  
 STONE | PIERRE | PEDRA [R12C] - FM3501ST

9,7X59,7cm 4"X24"

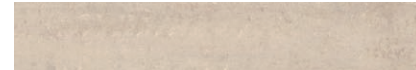

POLISHED | POLI | POLIDO - FM3502PO  
 MATT | MATE [R10A] - FM3503MT  
 HAMMERED EFFECT | BOUCHARDÉ | BUJARDADO [R11C] - FM3504EF  
 STONE | PIERRE | PEDRA [R12C] - FM3505ST

\*\* FINISHING AVAILABLE UNDER REQUEST  
 \*\* ACABAMENTO DISPONÍVEL SOB CONSULTA

# GRANITY AIRCREAM

10,8mm

59,7X119cm 24"X47"



POLISHED | POLI | POLIDO - FM3510PO  
 MATT | MATE [R10A] - FM3511MT  
 HAMMERED EFFECT | BOUCHARDÉ | BUJARDADO [R11C] - FM3512EF  
 STONE | PIERRE | PEDRA [R12C] - FM3513ST

29,7X119cm 12"X47"



POLISHED | POLI | POLIDO - FM3514PO  
 MATT | MATE [R10A] - FM3515MT  
 HAMMERED EFFECT | BOUCHARDÉ | BUJARDADO [R11C] - FM3516EF  
 STONE | PIERRE | PEDRA [R12C] - FM3517ST

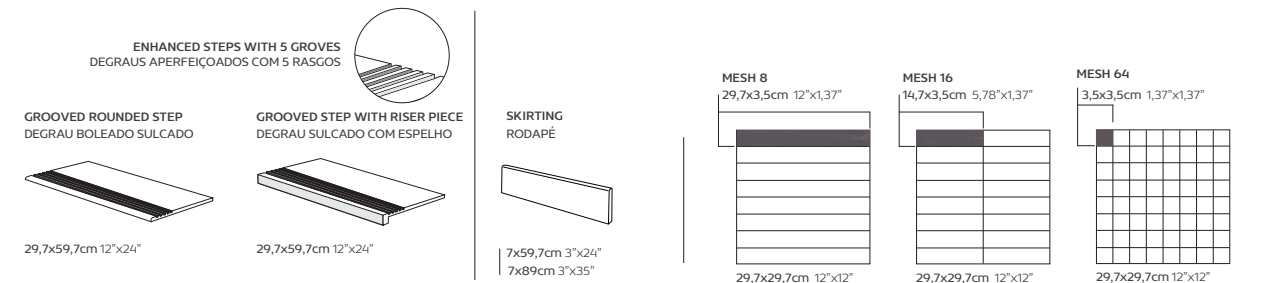

SIZES AVAILABLE UNDER REQUEST  
 FORMATOS DISPONÍVEIS SOB CONSULTA

14,7X119cm 6"X47"

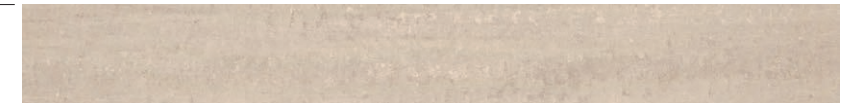

9,7X119cm 4"X47"

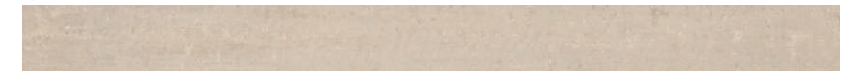

4,7X59,7cm 2"X24"



14,7X14,7cm 6"X6"

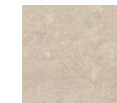

MONOCALIBER AND FULLY MODULAR FOR ALL SIZES [2mm joint]  
 MONOCALIBRE E TOTALMENTE MODULAR PARA TODOS OS FORMATOS [2mm joint]



# GRANITY AIRSEPIA

10,8mm

89X89cm 35"X35"



\*\* POLISHED | POLI | POLIDO - FM2930PO  
 MATT | MATE [R10A] - FM2630MT  
 HAMMERED EFFECT | BOUCHARDÉ | BUJARDADO [R11C] - FM2632EF  
 STONE | PIERRE | PEDRA [R12C] - FM2631ST

29,7X89cm 12"X35"



\*\* POLISHED | POLI | POLIDO - FM2925PO  
 MATT | MATE [R10A] - FM2750MT  
 HAMMERED EFFECT | BOUCHARDÉ | BUJARDADO [R11C] - FM2760EF  
 STONE | PIERRE | PEDRA [R12C] - FM2770ST

9,7X9,7cm 4"X4"



AVAILABLE IN MESH

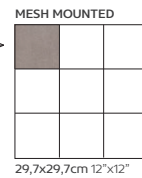

POLISHED | POLI | POLIDO - FM2652PO  
 MATT | MATE [R10A] - FM2642MT  
 HAMMERED EFFECT | BOUCHARDÉ | BUJARDADO [R11C] - FM2637EF  
 STONE | PIERRE | PEDRA [R12C] - FM2647ST

\*\* FINISHING AVAILABLE UNDER REQUEST  
 \*\* ACABAMENTO DISPONÍVEL SOB CONSULTA

# GRANITY AIRSEPIA

10,8mm

59,7X119cm 24"X47"



POLISHED | POLI | POLIDO - FM2800PO  
 MATT | MATE [R10A] - FM2613MT  
 HAMMERED EFFECT | BOUCHARDÉ | BUJARDADO [R11C] - FM2609EF  
 STONE | PIERRE | PEDRA [R12C] - FM2611ST

29,7X119cm 12"X47"



POLISHED | POLI | POLIDO - FM2793PO  
 MATT | MATE [R10A] - FM2782MT  
 HAMMERED EFFECT | BOUCHARDÉ | BUJARDADO [R11C] - FM2777EF  
 STONE | PIERRE | PEDRA [R12C] - FM2787ST

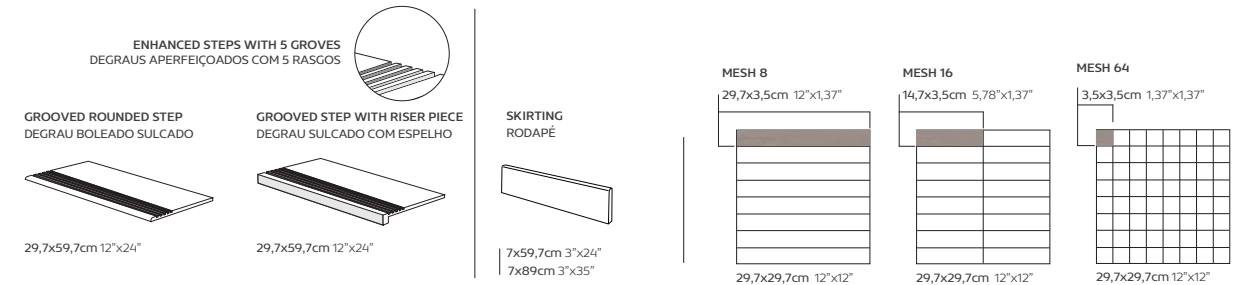

SIZES AVAILABLE UNDER REQUEST  
 FORMATOS DISPONÍVEIS SOB CONSULTA

14,7X119cm 6"X47"



9,7X119cm 4"X47"



4,7X59,7cm 2"X24"

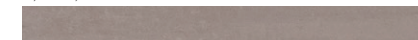

14,7X14,7cm 6"X6"



MONOCALIBER AND FULLY MODULAR FOR ALL SIZES [2mm joint]  
 MONOCALIBRE E TOTALMENTE MODULAR PARA TODOS OS FORMATOS [2mm joint]



# GRANITY AIRSOIL

10,8mm

89X89cm 35"X35"



\*\* POLISHED | POLI | POLIDO - FM3003PO  
 MATT | MATE [R10A] - FM2627MT  
 HAMMERED EFFECT | BOUCHARDÉ | BUJARDADO [R11C] - FM2629EF  
 STONE | PIERRE | PEDRA [R12C] - FM2628ST

29,7X89cm 12"X35"

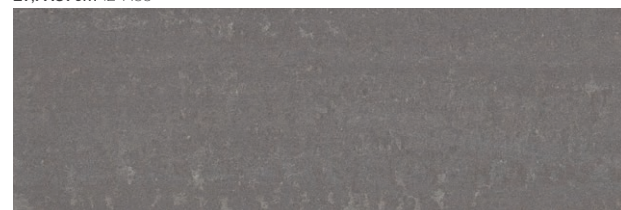

\*\* POLISHED | POLI | POLIDO - FM3004PO  
 MATT | MATE [R10A] - FM2749MT  
 HAMMERED EFFECT | BOUCHARDÉ | BUJARDADO [R11C] - FM2759EF  
 STONE | PIERRE | PEDRA [R12C] - FM2769ST

9,7X9,7cm 4"X4"



AVAILABLE IN MESH



29,7x29,7cm 12"x12"

POLISHED | POLI | POLIDO - FM2653PO  
 MATT | MATE [R10A] - FM2643MT  
 HAMMERED EFFECT | BOUCHARDÉ | BUJARDADO [R11C] - FM2638EF  
 STONE | PIERRE | PEDRA [R12C] - FM2648ST

\*\* FINISHING AVAILABLE UNDER REQUEST  
 \*\* ACABAMENTO DISPONÍVEL SOB CONSULTA

59,7X59,7cm 24"X24"

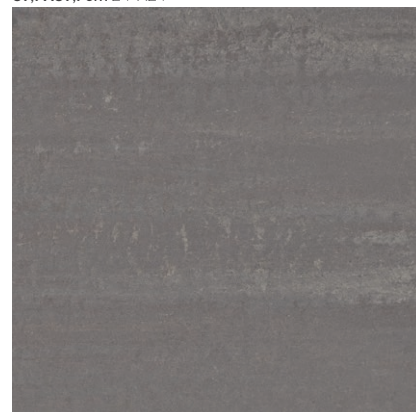

POLISHED | POLI | POLIDO - FM2740PO  
 MATT | MATE [R10A] - FM2588MT  
 HAMMERED EFFECT | BOUCHARDÉ | BUJARDADO [R11C] - FM2594EF  
 STONE | PIERRE | PEDRA [R12C] - FM2591ST

29,7X59,7cm 12"X24"

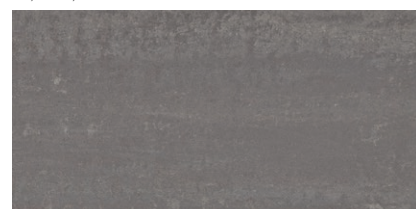

POLISHED | POLI | POLIDO - FM2734PO  
 MATT | MATE [R10A] - FM2724MT  
 HAMMERED EFFECT | BOUCHARDÉ | BUJARDADO [R11C] - FM2719EF  
 STONE | PIERRE | PEDRA [R12C] - FM2729ST

14,7X59,7cm 6"X24"

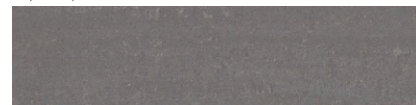

POLISHED | POLI | POLIDO - FM2714PO  
 MATT | MATE [R10A] - FM2704MT  
 HAMMERED EFFECT | BOUCHARDÉ | BUJARDADO [R11C] - FM2699EF  
 STONE | PIERRE | PEDRA [R12C] - FM2709ST

9,7X59,7cm 4"X24"



POLISHED | POLI | POLIDO - FM2694PO  
 MATT | MATE [R10A] - FM2684MT  
 HAMMERED EFFECT | BOUCHARDÉ | BUJARDADO [R11C] - FM2679EF  
 STONE | PIERRE | PEDRA [R12C] - FM2689ST

# GRANITY AIRSOIL

10,8mm

59,7X119cm 24"X47"



POLISHED | POLI | POLIDO - FM2801PO  
 MATT | MATE [R10A] - FM2614MT  
 HAMMERED EFFECT | BOUCHARDÉ | BUJARDADO [R11C] - FM2616EF  
 STONE | PIERRE | PEDRA [R12C] - FM2618ST

29,7X119cm 12"X47"

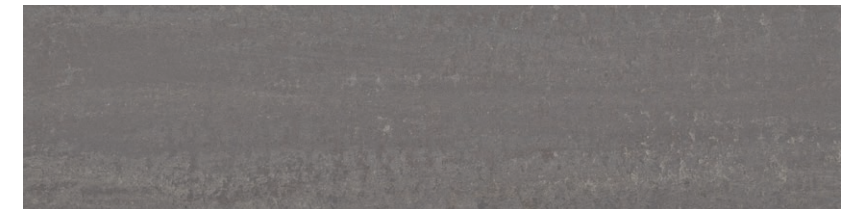

POLISHED | POLI | POLIDO - FM2792PO  
 MATT | MATE [R10A] - FM2781MT  
 HAMMERED EFFECT | BOUCHARDÉ | BUJARDADO [R11C] - FM2776EF  
 STONE | PIERRE | PEDRA [R12C] - FM2786ST

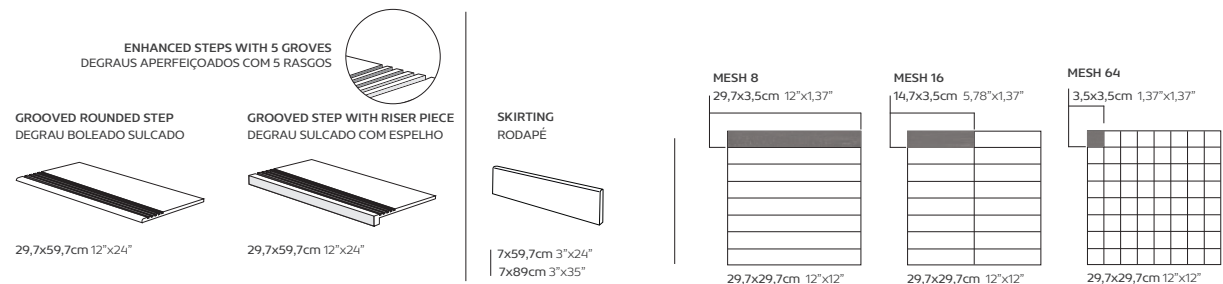

SIZES AVAILABLE UNDER REQUEST  
 FORMATOS DISPONÍVEIS SOB CONSULTA

14,7X119cm 6"X47"

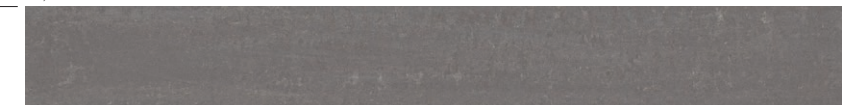

9,7X119cm 4"X47"



4,7X59,7cm 2"X24"



14,7X14,7cm 6"X6"



MONOCALIBER AND FULLY MODULAR FOR ALL SIZES [2mm joint]  
 MONOCALIBRE E TOTALMENTE MODULAR PARA TODOS OS FORMATOS [2mm joint]



# GRANITY AIR

**U** SCRATCH RESISTANCE  
RESISTANCE À L'ABRASÃO  
RESISTÊNCIA A ABRASÃO

**P** BREAKING STRENGTH  
RESISTANCE À LA FLEXION  
RESISTÊNCIA MECÂNICA

**E** BEHAVIOUR IN WATER PRESENCE  
COMPORTEMENT EN PRÉSENCE D'EAU  
COMPORTAMENTO EM PRESENÇA DE ÁGUA

**C** BEHAVIOUR IN PRESENCE OF CHEMICAL PRODUCTS  
COMPORTEMENT EN PRÉSENCE DE PRODUITS CHIMIQUES  
COMPORTAMENTO EM PRESENÇA DE PRODUTOS QUÍMICOS

UPEC
U2
U2S
U3
U3S
U4



## GRANITY AIR

REFERENCE:	PRODUCT/COLOR:	SIZE:	CLASSIFICATION:	REFERENCE:	PRODUCT/COLOR:	SIZE:	CLASSIFICATION:
FM1111MT	Granity Air Artic	597x1190x10.8	U4P3E3C2	FM2608MT	Granity Air Sepia	597x597x10.8	U4P4+E3C2
FM1114MT	Granity Air Artic	890x890x10.8	U4P3E3C2	FM2609EF	Granity Air Sepia	597x1190x10.8	U4P3E3C2
FM1119EF	Granity Air Artic	597x1190x10.8	U4P3E3C2	FM2611ST	Granity Air Sepia	597x1190x10.8	U4P3E3C2
FM1121EF	Granity Air Artic	890x890x10.8	U4P3E3C2	FM2613MT	Granity Air Sepia	597x1190x10.8	U4P3E3C2
FM1129ST	Granity Air Artic	597x1190x10.8	U4P3E3C2	FM2630MT	Granity Air Sepia	890x890x10.8	U4P3E3C2
FM1131ST	Granity Air Artic	890x890x10.8	U4P3E3C2	FM2631ST	Granity Air Sepia	890x890x10.8	U4P3E3C2
FM1644MT	Granity Air Artic	597x597x10.8	U4P4+E3C2	FM2632EF	Granity Air Sepia	890x890x10.8	U4P3E3C2
FM1645MT	Granity Air Artic	297x597x10.8	U4P4E3C2	FM2633ST	Granity Air Sepia	597x597x10.8	U4P4+E3C2
FM1652EF	Granity Air Artic	597x597x10.8	U4P4+E3C2	FM2634EF	Granity Air Sepia	597x597x10.8	U4P4+E3C2
FM1653EF	Granity Air Artic	297x597x10.8	U4P4E3C2	FM2718EF	Granity Air Sepia	297x597x10.8	U4P4E3C2
FM1655ST	Granity Air Artic	597x597x10.8	U4P4+E3C2	FM2723MT	Granity Air Sepia	297x597x10.8	U4P4E3C2
FM1656ST	Granity Air Artic	297x597x10.8	U4P4E3C2	FM2728ST	Granity Air Sepia	297x597x10.8	U4P4E3C2
FM2589MT	Granity Air Beige	597x597x10.8	U4P4+E3C2	FM1466MT	Granity Air Silver	597x597x10.8	U4P4+E3C2
FM2592ST	Granity Air Beige	597x597x10.8	U4P4+E3C2	FM1467MT	Granity Air Silver	297x597x10.8	U4P4E3C2
FM2595EF	Granity Air Beige	597x597x10.8	U4P4+E3C2	FM1474EF	Granity Air Silver	297x597x10.8	U4P4E3C2
FM2610EF	Granity Air Beige	597x1190x10.8	U4P3E3C2	FM1479ST	Granity Air Silver	597x597x10.8	U4P4+E3C2
FM2612ST	Granity Air Beige	597x1190x10.8	U4P3E3C2	FM1480ST	Granity Air Silver	297x597x10.8	U4P4E3C2
FM2615MT	Granity Air Beige	597x1190x10.8	U4P3E3C2	FM1844EF	Granity Air Silver	597x597x10.8	U4P4+E3C2
FM2624MT	Granity Air Beige	890x890x10.8	U4P3E3C2	FM931MT	Granity Air Silver	597x1190x10.8	U4P3E3C2
FM2625EF	Granity Air Beige	890x890x10.8	U4P3E3C2	FM935MT	Granity Air Silver	890x890x10.8	U4P3E3C2
FM2626ST	Granity Air Beige	890x890x10.8	U4P3E3C2	FM941EF	Granity Air Silver	597x1190x10.8	U4P3E3C2
FM2716EF	Granity Air Beige	297x597x10.8	U4P4E3C2	FM944EF	Granity Air Silver	890x890x10.8	U4P3E3C2
FM2721MT	Granity Air Beige	297x597x10.8	U4P4E3C2	FM949ST	Granity Air Silver	597x1190x10.8	U4P3E3C2
FM2726ST	Granity Air Beige	297x597x10.8	U4P4E3C2	FM952ST	Granity Air Silver	890x890x10.8	U4P3E3C2
FM1346MT	Granity Air Coal	597x597x10.8	U4P4+E3C2	FM2588MT	Granity Air Soil	597x597x10.8	U4P4+E3C2
FM1347MT	Granity Air Coal	297x597x10.8	U4P4E3C2	FM2591ST	Granity Air Soil	597x597x10.8	U4P4+E3C2
FM1355EF	Granity Air Coal	297x597x10.8	U4P4E3C2	FM2594EF	Granity Air Soil	597x597x10.8	U4P4+E3C2
FM1360ST	Granity Air Coal	297x597x10.8	U4P4E3C2	FM2614MT	Granity Air Soil	597x1190x10.8	U4P3E3C2
FM1845EF	Granity Air Coal	597x597x10.8	U4P4+E3C2	FM2616EF	Granity Air Soil	597x1190x10.8	U4P3E3C2
FM1847ST	Granity Air Coal	597x597x10.8	U4P4+E3C2	FM2618ST	Granity Air Soil	597x1190x10.8	U4P3E3C2
FM804MT	Granity Air Coal	597x1190x10.8	U4P3E3C2	FM2627MT	Granity Air Soil	890x890x10.8	U4P3E3C2
FM808MT	Granity Air Coal	890x890x10.8	U4P3E3C2	FM2628ST	Granity Air Soil	890x890x10.8	U4P3E3C2
FM813EF	Granity Air Coal	597x1190x10.8	U4P3E3C2	FM2629EF	Granity Air Soil	890x890x10.8	U4P3E3C2
FM816EF	Granity Air Coal	890x890x10.8	U4P3E3C2	FM2719EF	Granity Air Soil	297x597x10.8	U4P4E3C2
FM823ST	Granity Air Coal	597x1190x10.8	U4P3E3C2	FM2724MT	Granity Air Soil	297x597x10.8	U4P4E3C2
FM826ST	Granity Air Coal	890x890x10.8	U4P3E3C2	FM2729ST	Granity Air Soil	297x597x10.8	U4P4E3C2
FM1184MT	Granity Air Frost	597x1190x10.8	U4P3E3C2	FM1498MT	Granity Air Steel	597x597x10.8	U4P4+E3C2
FM1188MT	Granity Air Frost	890x890x10.8	U4P3E3C2	FM1499MT	Granity Air Steel	297x597x10.8	U4P4E3C2
FM1195EF	Granity Air Frost	597x1190x10.8	U4P3E3C2	FM1507EF	Granity Air Steel	597x597x10.8	U4P4+E3C2
FM1198EF	Granity Air Frost	890x890x10.8	U4P3E3C2	FM1508EF	Granity Air Steel	297x597x10.8	U4P4E3C2
FM1205ST	Granity Air Frost	597x1190x10.8	U4P3E3C2	FM1512ST	Granity Air Steel	597x597x10.8	U4P4+E3C2
FM1209ST	Granity Air Frost	890x890x10.8	U4P3E3C2	FM1513ST	Granity Air Steel	297x597x10.8	U4P4E3C2
FM1708MT	Granity Air Frost	597x597x10.8	U4P4+E3C2	FM971MT	Granity Air Steel	597x1190x10.8	U4P3E3C2
FM1709MT	Granity Air Frost	297x597x10.8	U4P4E3C2	FM975MT	Granity Air Steel	890x890x10.8	U4P3E3C2
FM1715EF	Granity Air Frost	597x597x10.8	U4P4+E3C2	FM980EF	Granity Air Steel	597x1190x10.8	U4P3E3C2
FM1716EF	Granity Air Frost	297x597x10.8	U4P4E3C2	FM984EF	Granity Air Steel	890x890x10.8	U4P3E3C2
FM1720ST	Granity Air Frost	597x597x10.8	U4P4+E3C2	FM988ST	Granity Air Steel	597x1190x10.8	U4P3E3C2
FM1721ST	Granity Air Frost	297x597x10.8	U4P4E3C2	FM992ST	Granity Air Steel	890x890x10.8	U4P3E3C2
FM2597MT	Granity Air White	890x890x10.8	U4P3E3C2	FM2597MT	Granity Air White	890x890x10.8	U4P3E3C2
FM2598ST	Granity Air White	890x890x10.8	U4P3E3C2	FM2598ST	Granity Air White	890x890x10.8	U4P3E3C2
FM2599EF	Granity Air White	890x890x10.8	U4P3E3C2	FM2599EF	Granity Air White	890x890x10.8	U4P3E3C2
FM2621MT	Granity Air White	597x597x10.8	U4P4+E3C2	FM2621MT	Granity Air White	597x597x10.8	U4P4+E3C2
FM2720EF	Granity Air White	297x597x10.8	U4P4E3C2	FM2720EF	Granity Air White	297x597x10.8	U4P4E3C2
FM2725MT	Granity Air White	297x597x10.8	U4P4E3C2	FM2725MT	Granity Air White	297x597x10.8	U4P4E3C2
FM2730ST	Granity Air White	297x597x10.8	U4P4E3C2	FM2730ST	Granity Air White	297x597x10.8	U4P4E3C2
FM2736EF	Granity Air White	597x597x10.8	U4P4+E3C2	FM2736EF	Granity Air White	597x597x10.8	U4P4+E3C2
FM2737ST	Granity Air White	597x597x10.8	U4P4+E3C2	FM2737ST	Granity Air White	597x597x10.8	U4P4+E3C2
FM2795EF	Granity Air White	597x1190x10.8	U4P3E3C2	FM2795EF	Granity Air White	597x1190x10.8	U4P3E3C2
FM2796MT	Granity Air White	597x1190x10.8	U4P3E3C2	FM2796MT	Granity Air White	597x1190x10.8	U4P3E3C2
FM2797ST	Granity Air White	597x1190x10.8	U4P3E3C2	FM2797ST	Granity Air White	597x1190x10.8	U4P3E3C2

**MATERIAL**  
UNGLAZED DOUBLE-LOADED PORCELAIN STONEWARE

**PRODUCTION**  
DOUBLE-LOADING TECHNOLOGY WITH POWDER HOMOGENIZATION AND HIGH GRANULOMETRY REDUCTION [ ≤ 150µm ]  
HYDRAULIC ISOSTATIC VERTICAL PRESSING [ ≥ 500Kg/cm² ]  
SINGLE FIRING WITH EXTRA LONG CYCLE AND HIGH TEMPERATURE [ 1220-1230°C ]  
AUTOMATIC SQUARING AND RECTIFYING OPERATIONS FOR ALL PIECES

## GRANITY AIR

TECHNICAL FEATURES: DADOS TÉCNICOS:	STANDARDS SPECIFICATIONS VALORES NORMAS	GRANITY AIR AVERAGE VALUES VALORES MÉDIOS	TEST NORM NORMA DE ENSAIO
EN 14411; ANNEXE G   ANEXO G; GROUP   GRUPO   GRUPO Bla			
<b>LENGTH AND WIDTH TOLERANCE</b> DESVIO MÁXIMO PARA COMPRIMENTO E LARGURA	± 0,6%	± 0,3%	
<b>THICKNESS TOLERANCE</b> DESVIO MÁXIMO PARA ESPESSURA	± 5%	± 3%	
<b>STRAIGHTNESS OF SIDES TOLERANCE</b> DESVIO MÁXIMO DA RECTILINEARIDADE	± 0,5%	± 0,3%	ISO 10545-2
<b>RECTANGULARITY TOLERANCE</b> DESVIO MÁXIMO DA ORTOGONALIDADE	± 0,5%	± 0,3%	
<b>FLATNESS TOLERANCE</b> DESVIO MÁXIMO DE PLANARIDADE	± 0,5%	± 0,3%	
<b>WATER ABSOPTION</b> ABSORÇÃO DE ÁGUA	≤ 0,5%	≤ 0,1%	ISO 10545-3
<b>MODULUS OF RUPTURE</b> MÓDULO DE RUPTURA	≥ 35 N/mm²	≥ 45 N/mm²	ISO 10545-4
<b>BREAKING STRENGTH</b> FORÇA DE RUPTURA	≥ 1300 N	≥ 2500 N	
<b>DEEP ABRASION RESISTANCE</b> RESISTÊNCIA À ABRASÃO PROFUNDA	≤ 175 mm²	≤ 130 mm²	ISO 10545-6
<b>LINEAR THERMAL EXPANSION</b> DILATAÇÃO TÉRMICA LINEAR	<b>DECLARED VALUE</b> VALOR DECLARADO	≤ 7X10 <sup>-6</sup> / K <sup>-1</sup>	ISO 10545-8
<b>THERMAL SHOCK RESISTANCE</b> RESISTÊNCIA AO CHOQUE TÉRMICO	<b>ORDERED</b> REQUERIDA	<b>RESISTANT</b> RESISTENTE	ISO 10545-9
<b>FROST RESISTANCE</b> RESISTÊNCIA AO GELO	<b>ORDERED</b> REQUERIDA	<b>RESISTANT</b> RESISTENTE	ISO 10545-12
<b>RESISTANCE TO CHEMICALS</b> (ACIDS AND ALKALIS) RESISTÊNCIA AOS QUÍMICOS (ÁCIDOS E BASES)	<b>DECLARED VALUE</b> VALOR DECLARADO	<b>CLASS HA</b> CLASSE HA	ISO 10545-13
<b>RESISTANCE TO CHEMICALS</b> (HOUSEHOLD CHEMICALS & SWIMMING POOL ADDITIVES) RESISTÊNCIA AOS QUÍMICOS (PRODUTOS QUÍMICOS DOMÉSTICOS E ADITIVOS PARA ÁGUA DE PISCINAS)	<b>MINIMUM CLASS B</b> MÍNIMO CLASSE B	<b>CLASS A</b> CLASSE A	
<b>STAIN RESISTANCE</b> RESISTÊNCIA À MANCHA	<b>DECLARED VALUE</b> VALOR DECLARADO	4	ISO 10545-14
	<b>CLASS A</b> ≥ 12° <b>CLASS B</b> ≥ 18° <b>CLASS C</b> ≥ 24°	<b>MATT</b> [MT] A <b>NATURAL</b> [NT] A <b>HAMMERED EFFECT</b> [EF] C <b>EFEITO BUJARDADO</b> [EB] C <b>STONE</b> [ST] C <b>PEDRA</b> [PD] C	DIN 51097
<b>SLIP RESISTANCE</b> RESISTÊNCIA AO ESCORREGAMENTO	<b>R9</b> 6° - 10° <b>R10</b> 10° - 19° <b>R11</b> 19° - 27° <b>R12</b> 27° - 35° <b>R13</b> > 35°	<b>MATT</b> [MT] R10 <b>NATURAL</b> [NT] R10 <b>HAMMERED EFFECT</b> [EF] R11 <b>EFEITO BUJARDADO</b> [EB] R11 <b>STONE</b> [ST] R12 <b>PEDRA</b> [PD] R12	DIN 51130



It is guaranteed the compliance with the values required by the norm EN 14411. Typical value is merely indicative and can differ from real data. | La conformité à la norme EN14411 est garantie. La valeur typique annoncée est purement indicative, pouvant différer des valeurs réelles. | É garantido o cumprimento da norma EN14411. O valor típico anunciado é meramente indicativo, podendo variar dos dados reais.

\*\* test carried out by certified external laboratories whose results are available upon request at our head office. pavigres is willing to check the lot you are interested in purchasing at our own laboratories. the anti-slip performance is guaranteed at the time of delivering the product. | Tests effectués par des laboratoires extérieurs accrédités et à la disposition de toute personne intéressée auprès de nos bureaux. pavigres est disponible pour vérifier dans ses laboratoires un lot qui vous souhaitez acheter. la performance antidérapante est garantie au moment de la livraison du produit. | Testes efetuados por laboratórios exteriores acreditados cujos resultados estão disponíveis na nossa sede sob solicitação. a pavigres está disponível para verificar nos seus laboratórios um lote que pretendam adquirir. a performance antiderrapante é garantida a altura da entrega do produto.

⚠ No claims accepted after ceramic tiles are fixed | Aucune réclamation ne sera acceptée après la pose du carrelage | Não se aceitam reclamações depois do mosaico cerâmico aplicado.







ART WOULD BE THE ABILITY TO IMITATE NATURE  
REPRODUCING IT, WOULD BE A PRODIGY.

ARTE SERIA A CAPACIDADE DE IMITAR A NATUREZA  
REPRODUZI-LA SERIA UM PRODÍGIO.



## NATURE

### AT THE ORIGIN OF EVERYTHING

Sustainable development is the challenge of today's companies. In Pavigrés Cerâmicas, S.A. we are aware of this reality and we take the challenge seriously.

For several years now, there's been a growing environmental awareness in the group, based on a principle of continuous improvement of environmental performance, not only because of the impact that today's actions have on the resources available for future generations but also because of the immediate impact on production costs and competitiveness. The company adopts an approach of environmental protection and pollution prevention, both at the level of production processes and products, trying to reduce the consumption of resources: raw materials, energy and water, which are vital components of all processes.

Reducing resource consumption is one of the main objectives within the Quality and Environmental Management System, according to the ISO NP 9001:2015 and ISO NP 14001:2015 standards, for which the organization is certified. Actions and goals have been defined to try to guarantee this objective. This goal can only be achieved with a proactive attitude, continuously seeking the means that allow us to effectively adapt equipment and processes to new technologies available.

## A NATUREZA

### NA ORIGEM DE TUDO

O desenvolvimento sustentável é o desafio das empresas de hoje. Na Pavigrés Cerâmicas, S.A estamos conscientes dessa realidade e encaramos o desafio com seriedade.

Desde há vários anos tem sido crescente a consciencialização ambiental no grupo, assente num princípio de melhoria contínua do desempenho ambiental, não apenas devido ao impacto que as ações de hoje têm nos recursos disponíveis para as futuras gerações, mas também devido ao impacto imediato nos custos de produção e na competitividade. A empresa adota uma abordagem de proteção do ambiente e prevenção da poluição, tanto ao nível dos processos de produção como dos produtos, tentando reduzir o consumo de recursos: matérias-primas, energia e água, que são componentes vitais de todos os processos.

A redução do consumo de recursos é um dos principais objetivos no âmbito do Sistema de Gestão de Qualidade e Ambiente, segundo as Normas ISO NP 9001:2015 e ISO NP 14001:2015, pelas quais a organização é certificada. Definiram-se ações e metas para procurar garantir esse objetivo. Tal objetivo só se alcança com uma atitude pró-ativa, procurando de forma incessante os meios que nos permitam uma adequação efetiva de equipamentos e processos a novas tecnologias disponíveis.



## THE PAVIGRÉS GROUP INDUSTRIAL STRUCTURE

The Pavigrés Group is dedicated to the manufacturing of ceramic floor and wall tiles and consists of 4 production units: Pavigrés and Grespor in Anadia, Cerev in Mealhada and Pavigrés II in Bustos. We have about 750 employees and an installed capacity of 10 million m<sup>2</sup>/year.

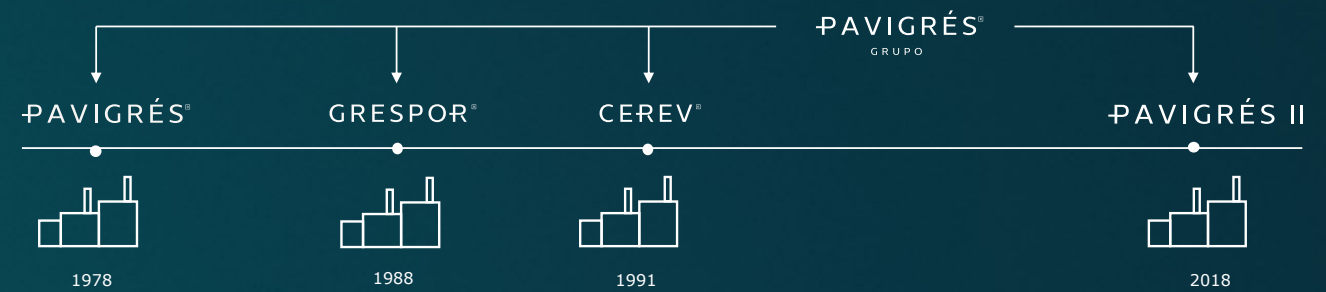

## O GRUPO PAVIGRÉS ESTRUTURA INDUSTRIAL

O Grupo Pavigrés dedica-se ao fabrico de pavimento e revestimento cerâmico e é constituído por 4 unidades de produção: Pavigrés e Grespor em Anadia, Cerev na Mealhada e Pavigrés II em Bustos. Contamos com a colaboração de cerca de 750 trabalhadores e temos uma capacidade instalada de 10 milhões de m<sup>2</sup>/ano.



## GOOD PRACTICES, PILLARS FOR SUSTAINABLE DEVELOPMENT

We focus not only on the impact that today's actions have on the resources available for future generations, but also on the immediate impact that these actions have on production costs and on our competitiveness. Sustainability is based on fighting waste, and it is precisely in the efficiency of companies that their competitive advantage may lie.

This can only be achieved with a proactive attitude, which materializes with the adoption of good practices, already rooted in Pavigrés, and which are part of its Strategy.

## BOAS PRÁTICAS, PILARES PARA O DESENVOLVIMENTO SUSTENTÁVEL

Colocamos o nosso foco não apenas no impacto que as ações de hoje têm nos recursos disponíveis para as gerações futuras, mas também no impacto imediato que estas ações têm nos custos de produção e na nossa competitividade. A sustentabilidade baseia-se no combate ao desperdício, e é precisamente na eficiência das empresas que pode residir a sua vantagem competitiva.

Tal só se alcança com uma atitude pró-ativa, que se materializa com a adoção de boas práticas, já enraizadas na Pavigrés, e que fazem parte da sua Estratégia.



**ECONOMIC DEVELOPMENT**  
DESENVOLVIMENTO ECONÓMICO



**SOCIAL DEVELOPMENT**  
DESENVOLVIMENTO SOCIAL



**ENVIRONMENTAL DEVELOPMENT**  
DESENVOLVIMENTO AMBIENTAL





RESOURCE MANAGEMENT - ENERGY EFFICIENCY  
GESTÃO DE RECURSOS - EFICIÊNCIA ENERGÉTICA

- Recovery of hot air from the cooling zone of the kilns for pre-heating the product in the greenhouses and dryers.
  - Recovery of gases resulting from combustion to help heat the atomisers.
  - Replacement of atomizers kilns and dryers with new and more energy efficient equipment.
  - Installation of high efficiency burners in the kilns.
  - Acquisition of high efficiency motors, energy class 3 (IE3).
  - Installation of variable speed drives in the motors.
  - Replacement of the roofs by translucent tiles that allows the entry of natural light.
  - Replacement of the existing lighting by LED lighting.
  - Computerized control of energy consumption associated with production equipment, such as atomisers, presses, dryers and kilns, which allows us to check consumption in real time.
- 
- Recuperação de ar quente da zona de arrefecimento dos fornos para pré-aquecimento do produto nas estufas e secadores.
  - Recuperação dos gases resultantes da combustão para auxiliar no aquecimento de atomizadores.
  - Substituição de atomizadores, fornos e secadores, por equipamentos novos, mais eficientes energeticamente.
  - Instalação de queimadores de alto rendimento nos fornos.
  - Aquisição de motores de alto rendimento, de classe energética 3 (IE3).
  - Colocação de variadores de velocidade nos motores.
  - Substituição dos telhados, com aplicação de telhas translúcidas que permitem a entrada de luz natural.
  - Substituição da iluminação existente por iluminação LED.
  - Controlo informatizado dos consumo energéticos associados aos equipamentos produtivos, como atomizadores, prensas, secadores e fornos, que nos permite em tempo real, verificar os consumos.





**RESOURCE MANAGEMENT - ENERGY EFFICIENCY**  
**GESTÃO DE RECURSOS - ENERGIAS RENOVÁVEIS**

- In a constant concern for the environmental impact, the Pavigres Group has been investing in photovoltaic plants to increase the use of clean energy and consequently reduce its CO<sub>2</sub> indirect emissions.
- In 2020, we made the first investment with the installation of 2222 photovoltaic panels at the Cerev manufacturing unit. Between 2021 and 2022, we installed 1850 photovoltaic panels at the Pavigres II manufacturing unit.
- In 2023, we reinforced our Cerev manufacturing unit's plant with the installation of an additional 1344 photovoltaic panels.
- In late 2023, the installation of 10280 panels in the Pavigrés and Grespor manufacturing units. This investment will be concluded in July 2024.
- Currently, the investments made in clean energy correspond, indirectly, to a reduction in emissions of approximately 2421 tons of CO<sub>2</sub> per year.

- Numa constante preocupação com o seu impacto ambiental, o Grupo Pavigres tem vindo a investir em centrais fotovoltaicas de forma a aumentar a utilização de energia limpa e consequentemente reduzir as suas emissões indiretas de CO<sub>2</sub>.
- Em 2020 efetuámos o primeiro investimento com a instalação de 2222 painéis fotovoltaicos na unidade fabril Cerev.
- Entre 2021 e 2022 instalámos 1850 painéis fotovoltaicos na unidade fabril Pavigres II.
- Em 2023 reforçámos a nossa central da unidade fabril Cerev com a instalação de mais 1344 painéis fotovoltaicos.
- Em finais de 2023 a instalação de 10280 painéis nas unidades fabris Pavigrés e Grespor, investimento este que ficará concluído em Julho de 2024.
- Atualmente os investimentos efetuados em energia limpas correspondem, de forma indireta, a uma redução de emissões de aproximadamente 2421 ton. CO<sub>2</sub>/ano.





**RESOURCE MANAGEMENT - RAW MATERIALS**  
GESTÃO DE RECURSOS - MATÉRIAS PRIMAS

- Development of new products with lower thickness, which allows a reduction in the consumption of raw materials and, consequently, inherent emissions to the process by its consumption and processing.
  - Growing demand and substitution of raw materials by similar materials with a reduced carbon content.
  - Regular energy audits that allow a detailed and exhaustive study of the production processes. They also make it possible to determine the investments necessary for the implementation of the measures identified, as well as their profitability and viability.
  - Reduction of clean water consumption through recirculation of treated residual water, which consequently reduces discharges into the water domain.
  - Dry rectification lines, which not only no longer require the use of water in the transformation process, but also allow the reincorporation of the dust from the rectification.
  - The declassification of the raw shard, atomised powder and cooked shard, allows us to forward them as by-products. Regarding the waste generated, we can state that 99.5% of the waste is sent for recovery operations.
- 
- Desenvolvimento de novos produtos com espessura inferior, que permite a redução de consumo de matérias-primas e, conseqüentemente, emissões inerentes ao processo pelo seu consumo e processamento.
  - Crescente procura e substituição de matérias-primas por similares com reduzido teor de carbono.
  - Realização de auditorias energéticas periódicas que possibilitam o estudo detalhado e exaustivo dos processos produtivos. Permitem ainda determinar os investimentos necessários para a execução das medidas identificadas assim como a rentabilidade e viabilidade das mesmas.
  - Redução do consumo de água limpa mediante a recirculação de água residual tratada, que conseqüentemente reduz as descargas no domínio hídrico.
  - Linhas de retificação a seco, que não só dispensam a utilização de água no processo de transformação, como permite a reincorporação do pó proveniente da retificação.
  - A desclassificação do caco cru, pó atomizado e caco cozido, permite-nos o seu encaminhamento como subproduto. Relativamente aos resíduos gerados, podemos afirmar que 99.5% dos resíduos são encaminhados para operações de valorização.



We are aware that there is a long way to go and the struggle against obstacles is constant. It is our goal to reduce greenhouse gas emissions as much as possible, and to do everything within our power always with a view to sustainability and environmental protection.

Estamos conscientes que há um longo caminho a percorrer e que o confronto com obstáculos é constante. É nosso objetivo reduzir ao máximo as emissões de gases com efeito de estufa, e fazer o que estiver ao nosso alcance sempre no sentido da sustentabilidade e proteção do meio ambiente.

PAVIGRÉS<sup>®</sup>  
GRUPO

PRODUCT ENVIRONMENTAL DECLARATION  
DECLARAÇÃO AMBIENTAL DE PRODUTO



EN



PT





# MODULARITY MODULARIDADE

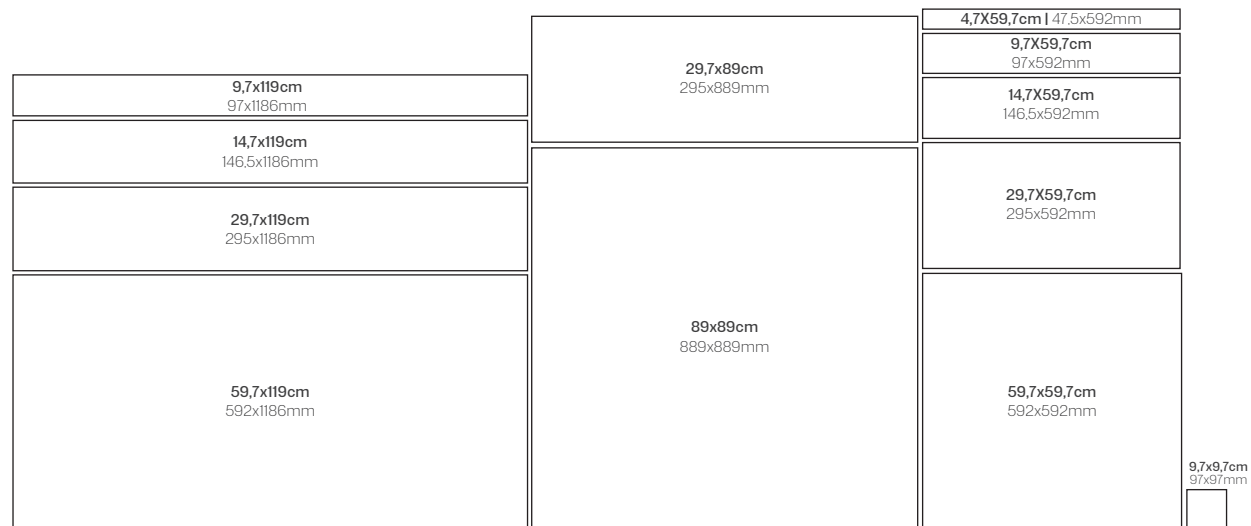

**Monocalibre and fully modular for all sizes ( 2mm joint)**  
 Monocalibre e totalmente modulares para todos os formatos (junta de 2mm)

# SHADE VARIATION COLOR GUIDE

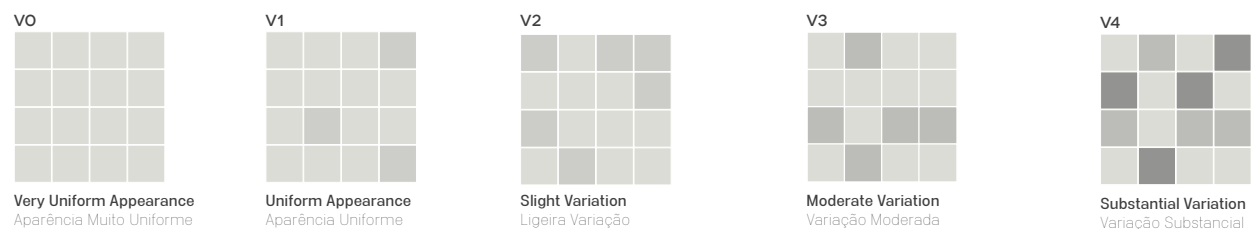

The variants to which the production process is exposed can cause slight variations on shade to the fixed standard colours.  
 The Pavigrés has right to change or eliminate, totally or partially, any reference or technical specification mentioned in this catalogue.  
 Printed colours in this catalogue are for guidance purposes only.

As variantes a que o processo de produção de cerâmica está sujeito podem provocar ligeiras variações de tonalidade em relação ao padrão de cor estabelecido.  
 A Pavigrés reserva-se o direito de alterar ou eliminar, total ou parcialmente, qualquer referência ou especificação técnica contida neste catálogo.  
 As cores impressas neste catálogo são apenas indicativas.

# IMPORTANT NOTES

The dimensions of the products presented in this catalogue are nominal; please ask pavigres for the exact dimensions of the products. All data presented in this catalogue is for information purposes only and shall not be understood as a binding contractual proposal. Pavigres reserves the right to, at any time, modify any data displayed in this catalogue without prior warning. The colours of the products in this catalogue are merely indicative and the actual product colour may differ significantly. Pavigres is continuously concerned to meet its clients' needs and frequently revamps its product ranges and therefore not all products displayed in the catalogue are necessarily certified. All rights reserved. The products and brands mentioned or represented in this catalogue are property of pavigres cerâmicas, s.A., All brands, drawings, photographs and texts are protected by law. It is strictly prohibited to copy, reproduce or modify wholly or partially any element of our marks, namely letters or words, graphics, pictures, colours or other figurative components, as well as logotypes, drawings, catalogue layout, designs atmospheres/environments or decoration graphically represented in the catalogue, without prior written consent of pavigres cerâmicas, s.A. The infringement of the principles laid out in this declaration may result in the civil and criminal liability of the offender.

As dimensões dos produtos apresentadas neste catálogo são nominais, pelo que, para obter as dimensões exactas dos produtos consulte a pavigres. Todos os dados constantes deste catálogo são de carácter informativo e não constituem uma proposta contratual vinculativa. A pavigres reserva-se o direito de, em qualquer momento, modificar qualquer dado constantes deste catálogo, sem aviso prévio. A cor dos produtos apresentados neste catálogo é meramente indicativa e a cor do produto final pode divergir significativamente. A pavigres constantemente preocupada em satisfazer as necessidades dos seus clientes, renova frequentemente a sua gama de produtos, pelo que, nem todos os produtos constantes deste catálogo são necessariamente certificados. Os produtos e marcas referidos ou representados neste catálogo são propriedade da pavigres cerâmicas, s.A., Estando as marcas, desenhos, fotografias ou textos devidamente protegidos por lei. É expressamente proibida a cópia, reprodução, alteração, no todo ou em parte, de qualquer elemento constitutivo ou representativo das marcas, designadamente palavras, símbolos, gráficas cores ou outros, bem como dos logótipos, desenhos, layouts de catálogo, ambientes de design ou decoração nele representados graficamente, sem autorização escrita da pavigres cerâmicas, s.A. A violação de alguma das disposições previstas nesta declaração poderá acarretar responsabilização civil e criminal do infractor.

# CLEANING & MAINTENANCE

After laying the tiles and grouting it is of utmost importance to perform the final cleaning procedures in order to eliminate any remaining residues (cement, grout, glue, paint) and also any other possible superficial residues. It is recommended that, immediately after the grout dry; the tile fixer should wipe the excess with a wet cloth (always following the manufacturer's instructions). Most of the noticed problems, once the laying works are complete, are due to inefficient / non existing cleaning procedures - for this type cleaning procedures we recommend an acid based detergent; on the daily cleaning procedures we recommended the use of a neutral detergent. For specific cleaning, kindly check the chart:

Após a aplicação dos mosaicos e respectiva junta é de extrema importância efectuar as operações de limpeza de obra, de forma a eliminar os resíduos de aplicação (cimentos, colas, juntas, tintas ) bem como possíveis resíduos superficiais do material. Recomenda-se que, imediatamente após a junta secar, se limpe os excessos destes produtos com um pano humedecido (seguindo sempre as indicações do fabricante). A maioria dos problemas manifestados após a obra deve-se a uma má e por vezes inexistente limpeza após a aplicação - para este tipo de limpeza recomendamos um desincrustante de base ácida; na limpeza quotidiana do material recomendamos a utilização de detergente neutro e na limpeza de manchas específicas, consultar a tabela:

TYPE OF STAIN TIPO DE SUJIDADE	TYPE OF DETERGENT ADVISED DETERGENTE OU SOLVENTE ACONSELHADO	PRODUCTS ADVISED BY FILA PRODUTOS RECOMENDADOS PELA FILA
<b>Calcareous Matter/ Deposits   Ink   Rust And Oxides   Mortar</b> Depósitos/ Eflorescências De Calcário   Tinta De Tinteiro   Ferrugem   Oxidação   Cimento	<b>Acid Detergent: Hydrochloric Acid: Muriatic Acid   Sulphuric Acid   Oxalic Acid</b> Detergente Com Base Ácida: Ácido Muriático   Ácido Nítrico   Ácido Sulfúrico   Ácido Oxálico	<b>Detertek</b>
<b>Beer/ Wine   Ice Cream And Coffee   Tea   Vegetable And Animal Fat   Urine   Vomit</b> Cerveja/ Vinho   Gelado E Café   Chá   Gordura Vegetal E Animal   Urina   Vômito	<b>Alkaline Detergent: Caustic Soda   Potash</b> Detergente Com Base Alcalina: Soda Cáustica   Potassa	<b>Fila PS/87   Fila SR/95</b>
<b>Rubber   Paints   Grease   Varnish   Shoe Polish   Wax Crayon   Hair Dye   Lipstick   Putties   Wax   Resins</b> Marca De Pneu   Tintas Resinosas Ou Esmalte   Óleo   Vernizes   Graxa   Lápis De Cera   Tinta De Cabelo   Baton   Betumes   Ceras   Resinas	<b>Solvent Detergent: Turpentine   Oil Of Turpentine   Thinner Trichloruethylen</b> Solventes: Trielina   Diluente   Aguarrás   Acetona	<b>Fila Ps/87   Fila Sr/95</b> <b>Filanospot (Grease   Shoe Polish)</b> (Óleo   Graxa) <b>Filasolv (Putties   Wax   Resins)</b> (Betumes, Ceras E Resinas)
<b>Felt Tipped Pen   Ketchup   Coke   Vinegar   Methylene Blue</b> Canetas De Feltro   Ketchup   Coca-Cola   Vinagre   Azul Metileno	<b>Alkaline Detergent   Acid Detergent</b> Detergente Com Base Alcalina   Ácido	<b>Fila PS/87   Fila SR/95</b>
<b>Graffiti</b> Tintas De Grafiti		<b>Fila Nopaint Star</b>
<b>Dirt On Grouting Joints</b> Sujidade Nas Juntas		<b>Fuganet</b>
<b>Daily Cleaning</b> Manutenção Quotidiana	<b>Normal Detergent</b> Detergente Comum	<b>Filacleaner</b>

Use greatest caution whenever working with acids or other strong cleaning chemicals. Read product label carefully and always follow manufacturers directions and precautions. The polished homogeneous technical porcelain tiles (UGL) of Pavigrés is treated with an anti-stain sealer in order to facilitate cleaning during and after the installation, however, it may not be sufficient, if it is not done a careful and timely cleaning of the material. For more information, please also check Clean and Maintenance on our website: [www.pavigres.com](http://www.pavigres.com). We recommend that one should search for information and if necessary ask the manufacturer for advice before you select a product to make sure that you select the right tile for the envisaged use.

Usar com muita prudência ácidos e outros produtos químicos concentrados. Seguir atentamente as instruções dos fabricantes indicadas nas embalagens. O grés porcelânico técnico polido (ugl) da pavigrés é protegido com um impermeabilizante anti-mancha, de modo a facilitar a sua limpeza durante e após a obra, no entanto, pode não ser suficiente, se não se proceder a uma limpeza cuidada e atempada do material. Para mais informação, por favor consultar a nossa página de internet: [www.pavigres.com](http://www.pavigres.com). Recomendamos que se informe cuidadosamente e se necessário contacte o fabricante antes de seleccionar um produto, para se assegurar que escolhe o produto certo para a utilização em vista.



# REFERENCE WORKS

LA QUEROLA D'ORDINO  
Andorra



Ateliers Jean Nouvel (AJN)  
Feri & Masi product: Unique Native

It is an innovative residential project, located in the village of Ordino, in a privileged setting, with easy access to all the services of the village on foot. Ordino is a parish of Andorra and is considered the most preserved valley in the country.

Source: *"laquerolaordino.com"*

NATURE INTEGRATION



In full nature

THE PROPOSAL



A monolith totally integrated in the mountain

# REFERENCE WORKS

LUISENHÖHE GESUNDHEITSRESORT SCHWARZWALD  
Horben - Freiburg



Gesundheitsresort Schwarzwald Luisenhöhe GmbH & Co KG  
Feri & Masi product: Granity Air

In the traditional location of the Luisenhöhe in Horben near Freiburg i. Br., the new construction project of the Black Forest health resort Luisenhöhe is being built in the middle of the unique natural landscape of the UNESCO Black Forest Biosphere Reserve .

Source: *"luisenhoehe-hotel.de"*

270° PANORAMIC VIEW



Modern Health & Nature Luxury (sketch preview © Geis & Brantner)

BLENDED WITH NATURE

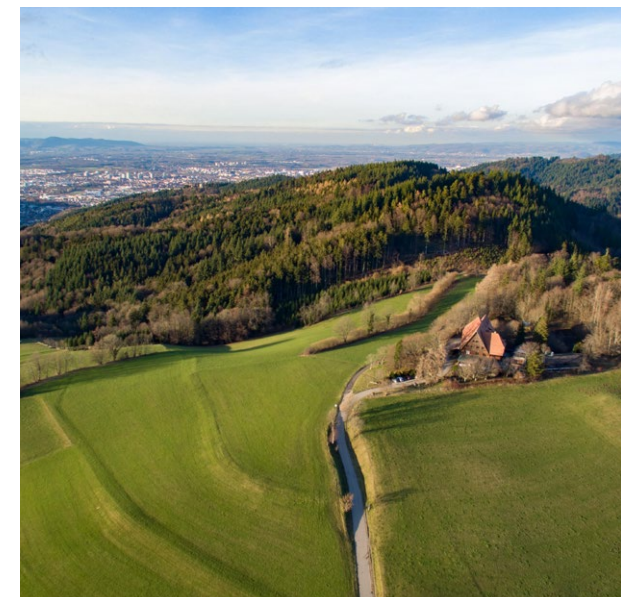

UNESCO Biosphere Reserve Black Forest



# REFERENCE WORKS

**LA QUEROLA D'ORDINO**  
Andorra

**GESUNDHEITSRESORT SCHWARZWALD**  
Freiburg

**JOHN LENNON AIRPORT**  
Liverpool, UK

**CORESI SHOPPING CENTER**  
Brasov, Romania

**UP-SITE TOWER**  
Brussels, Belgium

**HOTEL MELIÁ**  
Dusseldorf, Germany

**MAR SHOPPING**  
Matosinhos, Portugal

**MAISON KERJEAN**  
Ploulec'h - Côtes-d'Armor

**IPO – PORTUGUESE INSTITUTE OF ONCOLOGY**  
Porto, Portugal

**PORTAVENTURA PARK**  
Salou, Spain

**HSBC BANK**  
Dublin, Ireland

**PORT DU BON DIEU**  
Namur, Belgium

**LONGEVITY WELLNESS RESORT**  
Monchique, Portugal

**RIYAD BANK**  
Riyadh, Saudi Arabia

**GRANDE HOTEL DO LUSO**  
Luso, Portugal

**BMW SHOWROOM**  
Genk, Belgium

**87 SOLIGNY RESIDENCES**  
Cannes, France

**CROWNE PLAZA HOTEL**  
Manchester, UK

**BOHO HOTEL**  
Prague, Czech Republic

**RADISSON BLU HOTEL**  
Dubai, United Arab Emirates

**WIMBLEDON TENNIS COURTS**  
Wimbledon, UK

**AVENIDA PALACE HOTEL**  
Barcelona, Spain

**BRAVO SUPERMARKET**  
Azerbaijan

**PERLE OBAN HOTEL**  
Oban, Scotland

**FANPRIX SUPERMARKETS**  
France

**LOUISE METRO STATION**  
Belgium

**MARKS & SPENCER STORES**  
UK

**RENFE TRAIN STATIONS**  
Spain

**VODAFONE STORES**  
Netherlands

**FÓRUM BARREIRO SHOPPING CENTER**  
Portugal

**CAMPERA OUTLET SHOPPING**  
Portugal

**PALÁCIO DO GELO SHOPPING CENTER**  
Portugal

**ANEMONY SHOPS**  
Greece

**CAJASOL BANK BRANCHES**  
Spain

**HOTEL S. PEDRO**  
Portugal

**MATER CHRISTI PRIMARY SCHOOL**  
Belgium

**HORTIS RESIDENCES**  
Luxembourg

**NANDO'S RESTAURANTS**  
UK

**ST. DAVIDS HOTEL – CARDIFF**  
UK

**CARTIER STORE**  
Casablanca

**IBIS PORTLAND HOTEL**  
Manchester, UK

**ISPAK – ADMINISTRATION – BUILDING**  
Istanbul, Turkey

**LATYMER UPPER SCHOOL**  
London, UK

**EAST KILBRIDE SHOPPING CENTER**  
Glasgow, Scotland

**NATIONAL PIPING CENTER – MUSIC CENTER**  
Glasgow, Scotland

**ORLEBAR BROWN – MENS FASHION CHAIN**  
Glasgow, Scotland

**BMW MOTO SALES STAND**  
Athens, Greece

**SALSA STORES**  
Portugal

# REFERENCE WORKS

**STARBUCKS**  
Telford, Glasgow, Cardiff, Brents, Milton Keys, Keele, UK

**FINLAKE HOLIDAY PARKS**  
Chudleigh, U

**VICTORIA GATE SHOPPING CENTER**  
Leeds, UK

**ST. NICHOLAS PARK LEISURE CENTRE**  
Warwick, UK

**H&M – FASHION CHAIN**  
Exeter, UK

**ALOFT LONDON EXCEL**  
London, UK

**MILLENIUM CRUISE SHIP**

**SENATE HOUSE – UNIVERSITY**  
London, UK

**AVERY HEALTHCARE – RETIREMENT HOME**  
Northampton, UK

**NANDOS**  
Warrington, Cambridge, Lewisham, UK

**HEXHAM BUS STATION**  
Hexham, UK

**NOVOTEL**  
Canary Wharf, London, UK

**GAUCHO RESTAURANTS**  
Picadilly, London, UK

**THAMES TOWER – OFFICES**  
Reading, UK

**CHARTER PLACE SHOPPING CENTER**  
Watford, London, UK

**BIRMINGHAM CHILDRENS HOSPITAL**  
Birmingham, UK

**WELLINGTON PLACE – OFFICES**  
Leeds, UK

**EXCHANGE HOUSE OFFICES**  
Milton Keynes, UK

**BLACKBROOK LEISURE CENTRE & SPA**  
Tauton, UK

**LONDON FREEMENS SCHOOL SWIMMING POOL**  
London, UK

**ARNDAL SHOPPING CENTER**  
Manchester, UK

**BOROUGHMUIR HIGH SCHOOL**  
Edinburgh, Scotland

**QUEEN ELIZABETH UNIVERSITY HOSPITAL**  
Glasgow, Scotland

**TINY REBEL BREWING COMPANY – BREWERY**  
Newporth, South Wales, UK

**HOTELL ÄLVSJÖ**  
Stockholm, Sweeden

**Nº 1 & 2, 47 BELGRAVE SQUARE – RESIDENCES**  
Belgravia, London, UK

**WHITECHAPEL**  
London, UK

**SOUTHGATE – RESIDENCES**  
London, UK

**HG-GLASINDUSTRIE COMPANY**  
Belgium

**CARTIER STORE**  
Casablanca

**IBIS PORTLAND HOTEL**  
Manchester, UK

**ST. DAVIDS HOTEL**  
Cardiff, UK

**NANDO'S RESTAURANTS**  
UK

**BRAVO SUPERMARKETS**  
Azerbaijan

**BRAVO SUPERMARKETS**  
Azerbaijan

**LUX AIR FACILITIES**  
Luxembourg

**ROD LAVER ARENA**  
Melbourne, Australia

**UPS FACILITIES**  
Lummen, Belgium

**NORTHAMPTON BOYS SCHOOL**  
Northampton, UK

**LARUS – URBAN DESIGN COMPANY**  
Portugal

**HUNTINGDON CAR PARK**  
Hubtingdom, UK

**EVER – WR HOTEL**  
São João da Madeira, Portugal

**GOURMET BURGER KITCHEN RESTAURANTS**  
Resorts World, Birmingham, UK

**HUNTINGDON CAR PARK**  
Hubtingdom, UK

**GOURMET BURGER KITCHEN RESTAURANTS**  
Resorts World, Birmingham, UK



# PAVIGRÉS<sup>®</sup>

GRUPO

## SEDE:

Apartado 42 | EC Anadia  
3781-909 ANADIA - PORTUGAL

Tel: +351 231 510 600

export@pavigres.com

External market . Marché extérieur . Mercado externo  
comercial@pavigres.com

Internal market . Marché interne . Mercado interno

Gps: N 40 25.333 W 8 26.052  
Z.I. Almas das Domingas • 3780-244 ANADIA

## DELEGAÇÃO:

Lisboa

Empreendimento Portucalle - Lote 4.42.01  
Páteo Das Pirogas - Loja 33 - Bl. C3 - Piso 0  
1990-616 Lisboa

Tel: +351 218 960 110/1  
delegacao.lisboa@pavigres.com

Gps: N 38 46.616 W 9 05.711

## PAVIGRÉS FRANÇA

PARIS

16, Rue Lacuée  
75012 Paris

Tel: (01) 477 048 48

pavigresfrance@pavigres.com

Gps: 48°50'57.6"N 2°22'12.8"E

## GRÉSPOR ESPANHA

CASTELLON

C/3, Travessia del Palmeral  
12200 ONDA (CASTELLON)  
Tel: (964)626090 Fax: (964)626131  
gresporespana@pavigres.com

Gps: 39°57'23.0"N 0°11'57.0"W



CATÁLOGO PURE 2024

1ª Ed. 2024/03

Pavigrés Cerâmicas S.A.

Concept Design: Paulo Lima

Printed by: Lusoimpress