

Catalog • Catálogo • Catalogo

BRUMA

FLOWING
ART

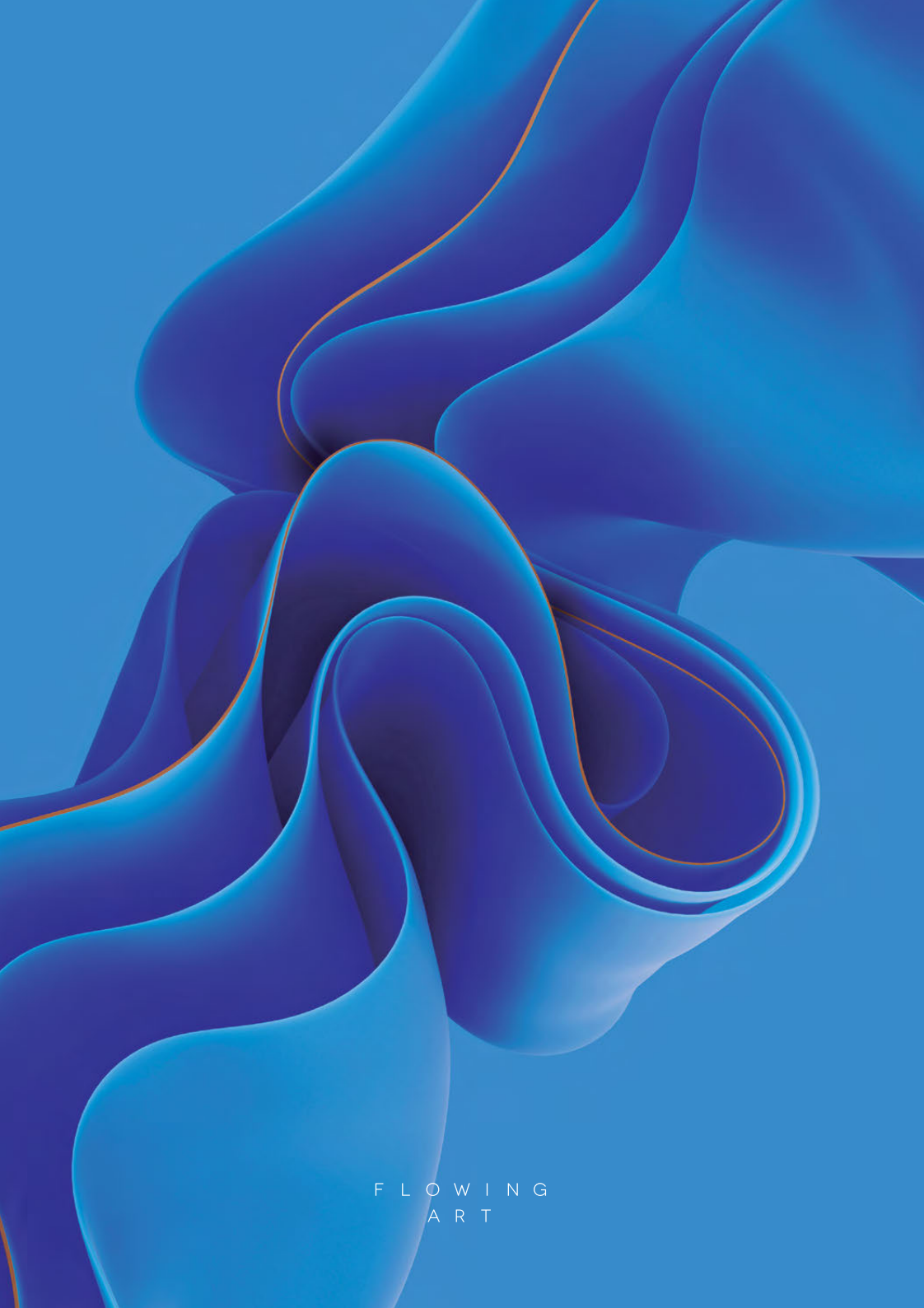

F L O W I N G
A R T

Index

Índice

Contenidos

- 04 BRUMA Flowing Art
- 07 BRUMA Colorful Life
- 08 BRUMA PVD

Flowing Art

- 10 Royale
- 12 Utopia
- 14 Navy
- 16 Genesi
- 18 Breeze
- 19 Adamastor
- 20 Hera
- 21 Avalon
- 22 Spring

Stainless Steel AISI 316/L

Inox
Acero inoxidable

- 24 X-Alpha

Blueline

- 26 Lusa
- 27 Leaf
- 28 Adagio
- 29 Nautic
- 30 Linea
- 31 Escudo
Lusitano
Coral

Intemporal

- 32 Clássico
- 33 Imperial

Kitchen

Cozinha

- 34 Cocina

Shower Systems

Sistemas de Duche

- 35 Sistemas de Ducha

Self-Closing & Electronic

Temporizadas & Electrónicas

- 36 Temporizado & Electrónico

Garden & Pools

Jardim & Piscina

- 37 Jardin & Piscina

Bath Accessories

Acessórios de Banho

- 38 Accesorios Baño

- 40 Beyond the eye

Technologies

Tecnologias

- 42 Tecnologías



BRUMA

Flowing Art

A benchmark for efficiency and design.

Present on the market for over 65 years, BRUMA is synonymous with experience, quality and innovation in the creation of water taps that perfectly balance aesthetics with high performance.

The attention and dedication to the process of creating BRUMA water taps reflect the focus and importance that the brand gives to the design of its products and the provided user experience. BRUMA's production process is increasingly sustainable and combines state-of-the-art industrial techniques with meticulous craftsmanship.

This alliance between the innovative character of the brand and the expertise resulting from decades of experience is translated into more than 25 collections of versatile and efficient products.

With a history guided by innovation, BRUMA constantly seeks to live up to its precursor legacy and its mission continues to be, just like it was 65 years ago, to achieve perfection in the development of products that excel in beauty and sophistication, keeping its high standards of quality and efficiency intact.





Uma referência de eficiência e do design.

Presente no mercado há mais de 65 anos, a BRUMA é sinónimo de experiência, qualidade e inovação na criação de torneiras que equilibram a estética das suas formas com um alto desempenho na sua função.

A atenção e dedicação ao processo de criação das torneiras BRUMA espelham o foco e a importância que a marca entrega ao design do seu produto e à experiência de utilização proporcionada.

O processo de produção da BRUMA é cada vez mais sustentável e articula técnicas industriais de ponta com um meticuloso trabalho artesanal. Esta aliança entre o carácter inovador da marca e a mestria que resulta de décadas de experiência está traduzida em mais de 25 coleções de produtos versáteis e eficientes.

Com uma história pautada pela inovação, a BRUMA procura constantemente fazer jus ao seu legado precursor e, tal como há 65 anos atrás, a sua missão continua a ser atingir a perfeição no desenvolvimento de produtos que primam pela beleza e sofisticação do seu design, mantendo intactos os seus elevados padrões de qualidade e eficiência.

Un referente en eficiencia y diseño.

Presente en el mercado desde hace más de 65 años, BRUMA es sinónimo de experiencia, calidad e innovación en la creación de grifería que equilibran a la perfección la estética con las altas prestaciones.

La atención y dedicación en el proceso de creación de la grifería BRUMA reflejan el enfoque y la importancia que la marca le da al diseño de sus productos y la experiencia que el usuario nos brinda.

El proceso de producción de BRUMA es cada vez más sostenible y combina técnicas industriales de última generación con un cuidado trabajo artesanal. Esta alianza entre el carácter innovador de la marca y el saber hacer fruto de décadas de experiencia se traduce en más de 25 colecciones de productos versátiles y eficientes.

Con una historia guiada por la innovación, BRUMA busca constantemente estar a la altura de su legado precursor y su misión sigue siendo, como lo fue hace 65 años, alcanzar la perfección en el desarrollo de productos que sobresalgan en belleza y sofisticación, manteniendo su alto estándares de calidad y eficiencia.



STEEL



BRUMA

Colorful Life

PLATED



VARNISHED

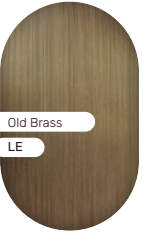
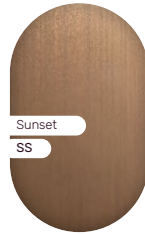
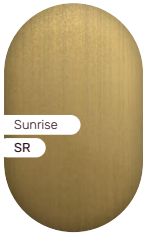

PVD

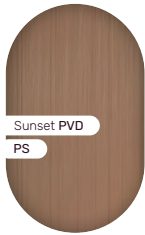
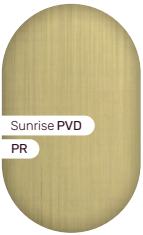
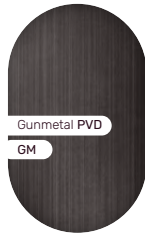

BRUMA PVD

The alchemy of colours

Immerse yourself in the alchemy of colours and indulge in a captivating experience for the senses, provided by elegant, perfect and durable tones, certified by the guaranteed quality of BRUMA products.

BRUMA's PVD (Physical Vapour Deposition) coating process provides tremendous colour flexibility for even and refined finishes and exceptional durability, due to a surface that is 3 times harder and 10 times more scratch resistant than a chrome finish.

Unlike other coating processes, PVD has a lower ecological impact as it results from a sustainable process that does not generate any waste.





A alquimia das cores

Mergulhe na alquimia das cores e desfrute de uma experiência cativante para os sentidos, proporcionada por tons elegantes, perfeitos e duráveis, com a garantia de qualidade BRUMA.

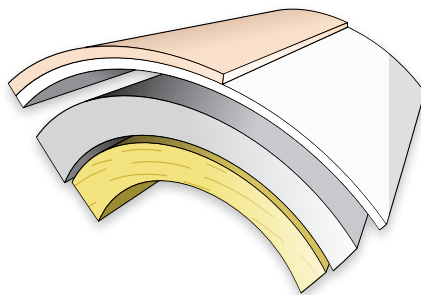
O processo de revestimento PVD (*Physical Vapour Deposition*) da BRUMA proporciona uma enorme flexibilidade de cores para um acabamento uniforme e com uma excecional durabilidade, graças a uma superfície 3 vezes mais dura e 10 vezes mais resistente a riscos do que o acabamento cromado.

Contrariamente a outros processos de revestimento, o PVD produz um menor impacto ecológico, uma vez que resulta de um processo sustentável que não gera quaisquer resíduos.



-  BRUMA PVD
-  BRUMA Chrome
BRUMA Cromado
BRUMA Cromo
-  Nickel
Níquel
Nickel
-  Brass
Latão
Latón

3x  Hardness
Dureza

10x  Scratch Resistant
Resistência a Riscos
Resistente a Arañazos

La alquimia de los colores

Sumérjase en la alquimia de los colores y disfrute de una experiencia cautivadora para los sentidos, proporcionada por tonos elegantes, perfectos y duraderos, certificados por la calidad garantizada de los productos BRUMA.

El proceso de recubrimiento PVD (Physical Vapor Deposition) de BRUMA nos brinda una gran flexibilidad de color para lograr acabados uniformes, refinados y de una durabilidad excepcional, debido a una superficie que es 3 veces más dura y 10 veces más resistente a los arañazos que cualquier acabado cromado.

A diferencia de otros procesos de recubrimiento, el PVD tiene un menor impacto en el medio ambiente, ya que es el resultado de un proceso sostenible que no genera residuos.



Flowing Art

COLLECTIONS • COLEÇÕES • COLECCIONES



Royal



192 250 1

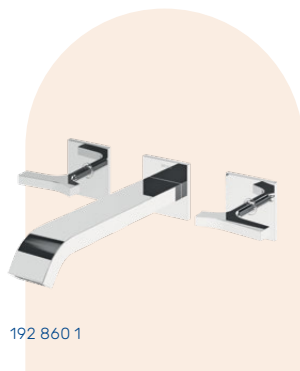

192 860 1

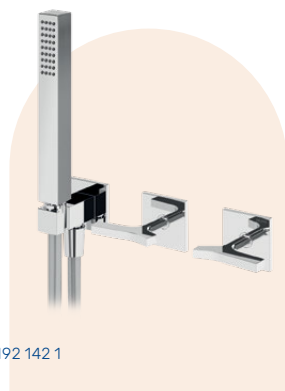

192 142 1



192 260 1

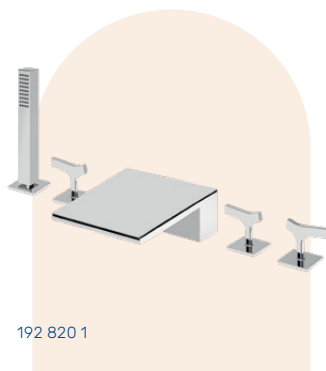

192 820 1

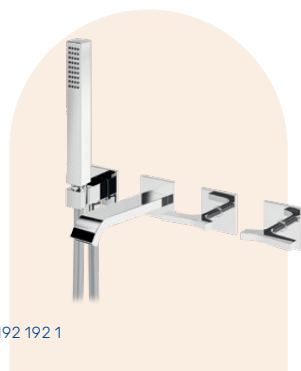

192 192 1



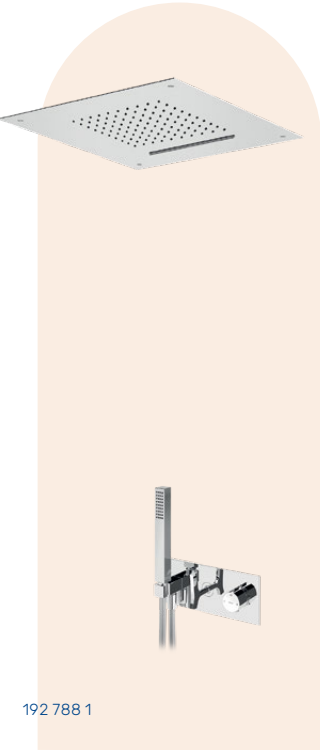
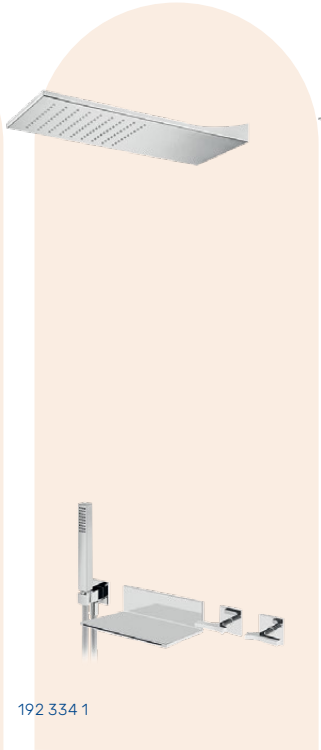
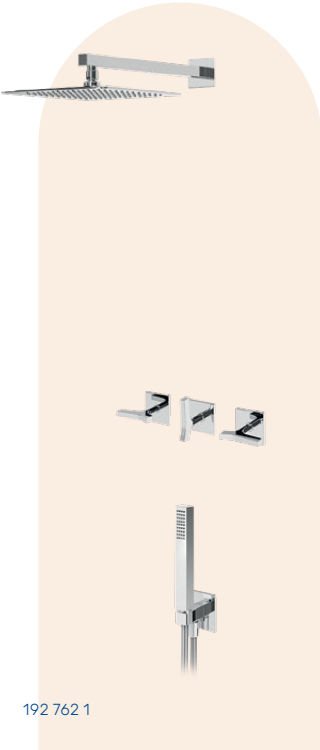

Utopia



183 250 1



183 860 0

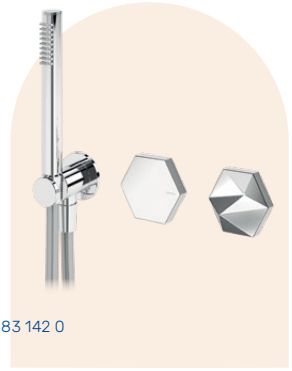

183 142 0



183 850 0



183 020 0

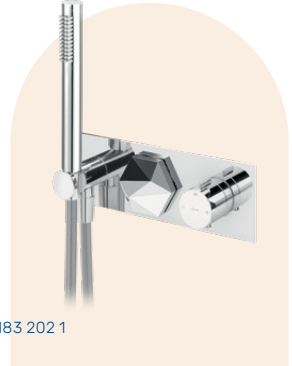

183 202 1



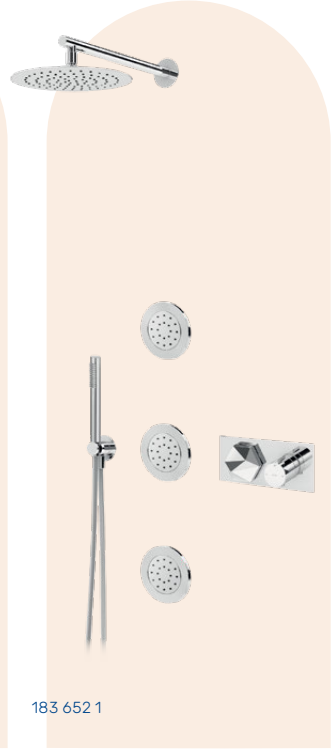
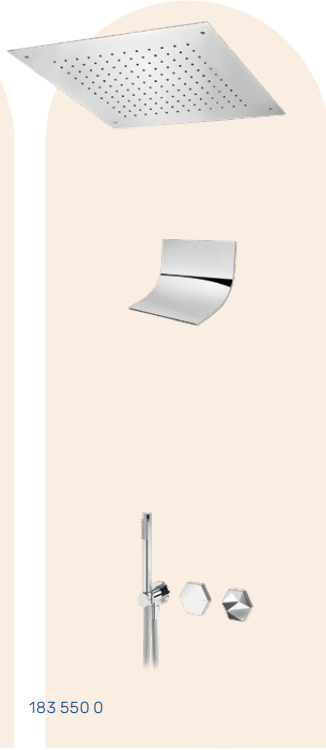
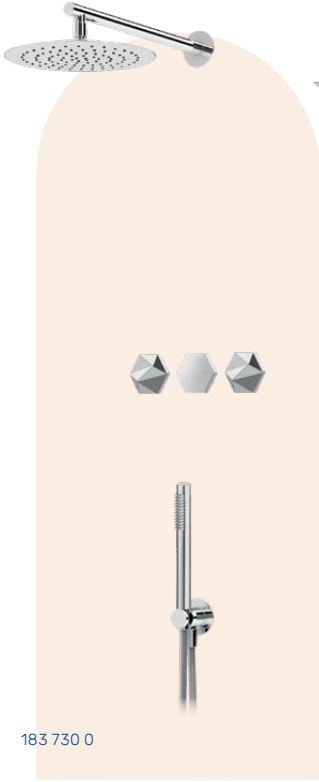

Navy



190 880 1



190 860 1



190 102 1



190 250 1



190 010 1



190 142 1



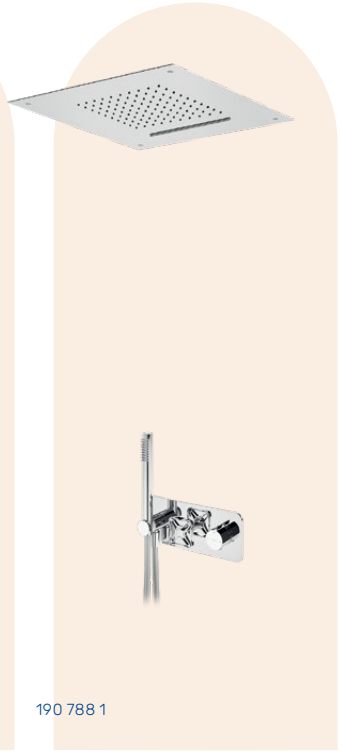



Genesis



191230 1



191860 1



191102 1



191260 1



191010 1



191142 1



191 312 1



191 332 1

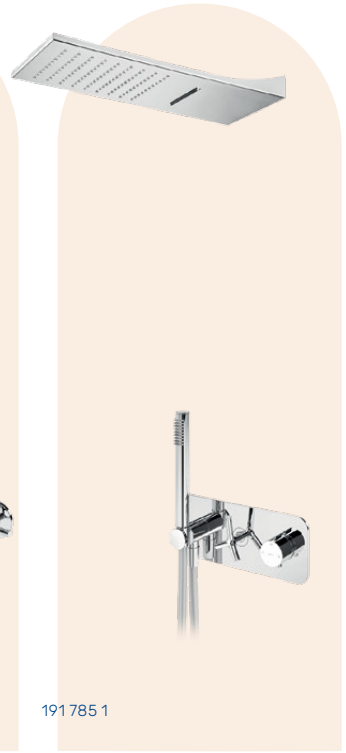

191 785 1





Breeze



168 010 1



168 230 1



168 200 1



168 840 1



168 330 1



168 800 1



Adamastor



301010 2

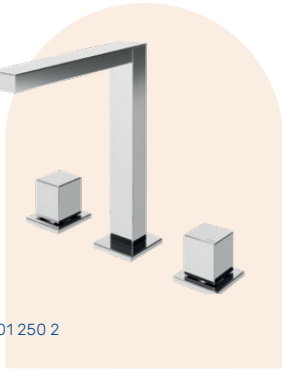

301250 2

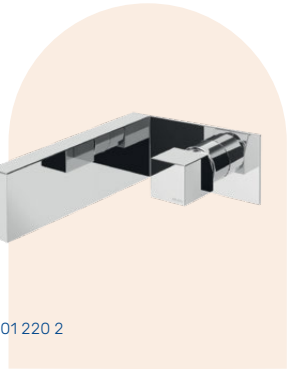

301220 2



301330 2

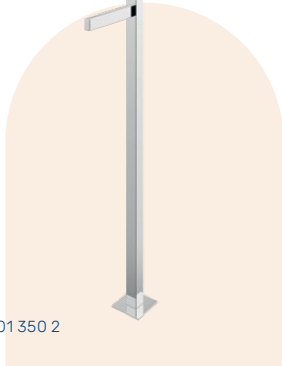

301350 2

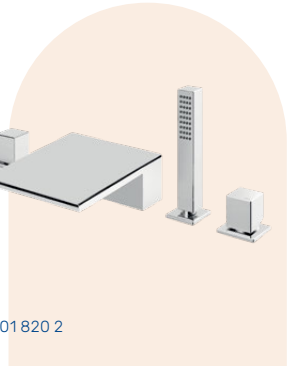

301820 2





Hera



106 220 0



106 250 0



106 010 0



106 880 0



106 230 0



106 810 0





Avalon



189 010 1

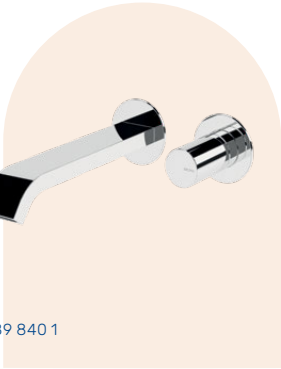

189 840 1



189 355 1



189 330 1



189 250 1



Spring



112 010 0



112 230 0



112 210 0

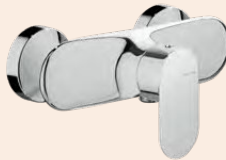

112 040 0

112 740 0



Stainless Steel Inox Acero Inoxidable

AISI 316/L

COLLECTIONS • COLEÇÕES • COLECCIONES





X-Alpha

AISI 316/L



186 010 1IS



186 840 1IS



186 230 1IS



186 240 1IS



186 321 1IS



186 980 1IS

BlueLine

COLLECTIONS • COLEÇÕES • COLECCIONES

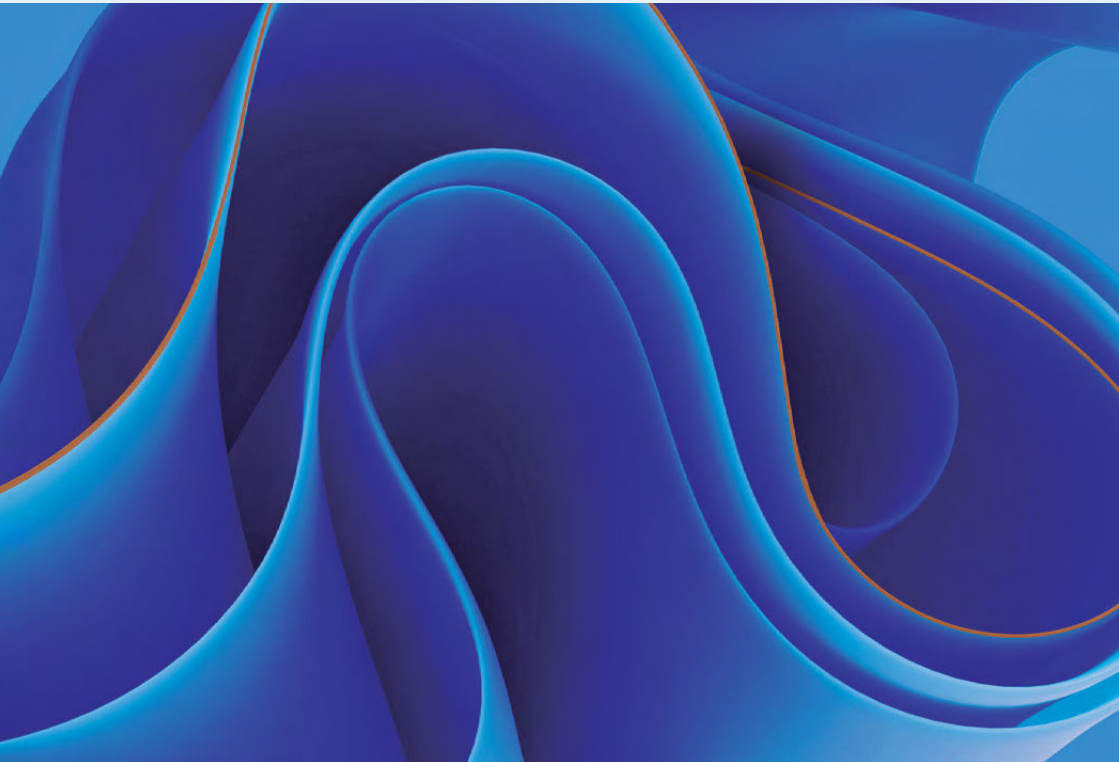



Lusa



101110.2

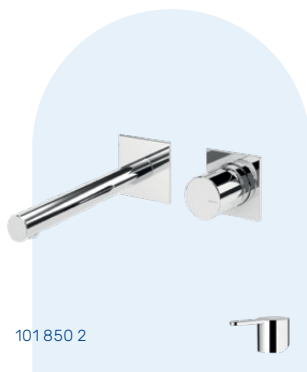

101850.2



101230.3



101250.1

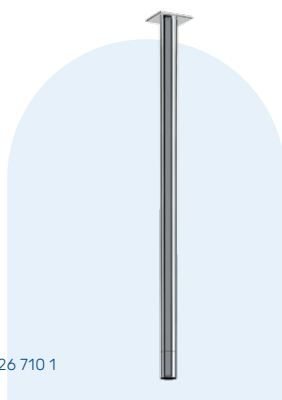

126710.1

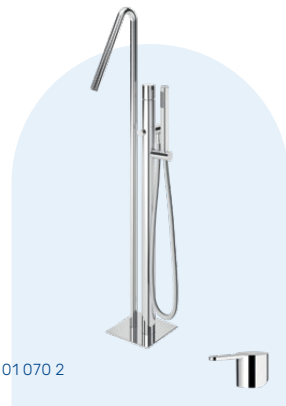

101070.2



Leaf



167 810 1



167 010 1



167 840 1



167 230 1



167 180 1



167 990 1





Adagio



193 010 1

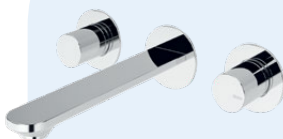

193 240 1

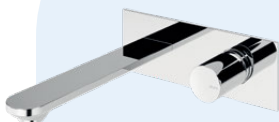
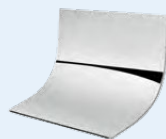

193 820 1

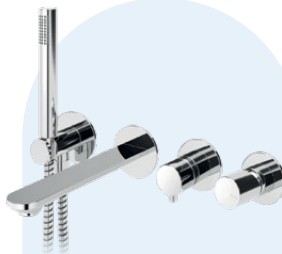

193 100 1



193 574 1





Nautic

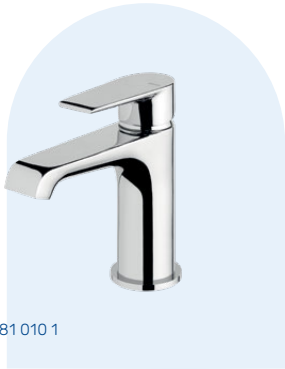

181 010 1



181 040 1

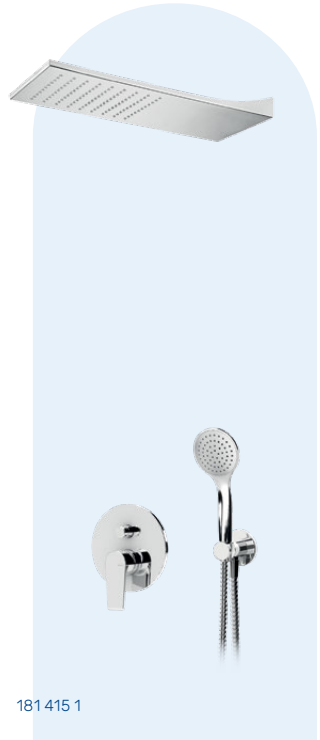

181 415 1



181 840 1



181 100 1





Linea



182 010 1



182 040 1



182 840 1



182 330 1



182 571 2





Escudo Lusitano Coral



Escudo
102 010 2



Lusitano
107 010 1



Coral
194 010 0

Clásico



118 013 0



118 210 0



118 252 0



118 360 0



118 240 0

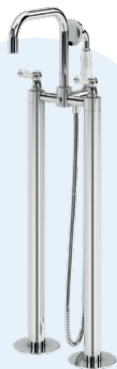

118 080 0





Imperial

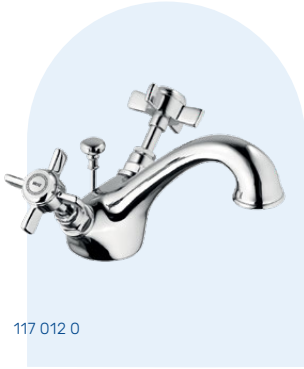

117 012 0

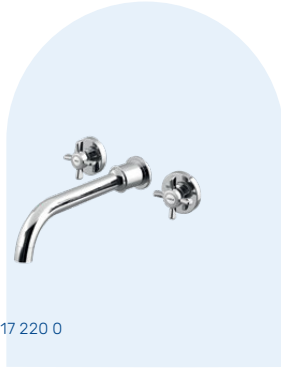

117 220 0



117 730 0



117 240 0



117 030 0

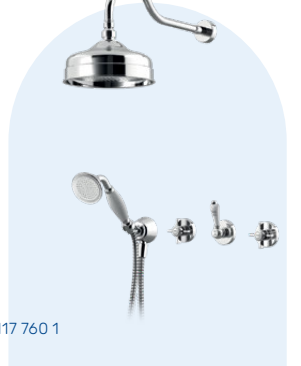

117 760 1



Kitchen Cozinha Cocina



122 700 0



107 050 5



122 003 5



197 010 1

INOX



107 052 6



107 054 1



Shower System Sistemas Duche Sistemas de Ducha

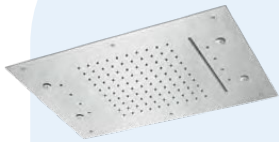

145 553 0

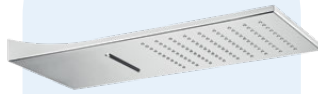

145 227 3

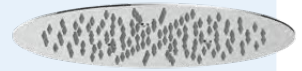

145 553 7

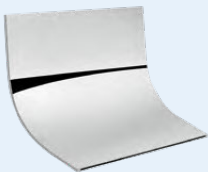

145 534 7



145 524 7



145 522 4



Electronic Electrónicas Electrónico



130 0117



130 0018



130 015 0



130 007 2



130 109 1



130 016 0



Garden & Pools Jardim & Piscina Jardin & Piscina



123 670 2IS

INOX



123 672 3IS

INOX



123 672 2IS

INOX



123 671 6IP

INOX



Bath Accessories

Acessórios de Banho

Accesorios Baño



X-Alpha
188 000 2IS

INOX



Cubis
176 000 4



Sintra
135 000 2



Artic
178 000 4



Aludra
179 000 4



Maris
177 000 4



Gerês
136 000 2







Beyond the eye

Admire beauty. Experience innovation.



NEW TECHNOLOGY

Beyond Collection by BRUMA

Innovation from within, in one single piece.

A benchmark for efficiency and design.

In sync with the avant-garde designs that define BRUMA solutions, the **Beyond Collection** represents the climax of the symbiosis between design, technology and efficiency.

As result of its technologically differentiating character, the **Beyond Collection series allows for a highly intuitive, safe and accurate installation process. Given its compact and universal composition and the inclusion of facilitating assembly elements (the bubble level, space for the screws on its plastic frame and location indicators for hot and cold water).**

Also, the built-in element allows a reduction by about 20% the number of steps necessary for its installation, resulting in a consequent cut of associated costs.

Sustainability is also a stone not left unturned by this technology, as it demands less use of plastic and other harming materials to the environment.

NOVA TECNOLOGIA

BRUMA: Beyond Collection

A inovação que vem do interior, numa única peça.

Em sintonia com os designs de vanguarda que definem as soluções BRUMA, a gama **Beyond Collection** representa o clímax da simbiose entre design, tecnologia e eficiência.

Fruto do seu carácter tecnologicamente diferenciador, a gama **Beyond Collection** possibilita um processo de instalação altamente intuitivo, seguro e preciso.

A facilidade e rapidez no processo de instalação deve-se a uma composição compacta e universal, bem como à inclusão de elementos que simplificam a montagem (o nível, espaço para parafusos na moldura de plástico e indicações de localização para água quente e fria). Inclusive, o elemento embutido permite reduzir em cerca de 20% o número de passos necessários à sua colocação, traduzindo-se numa consequente redução de custos associados.

O factor da sustentabilidade não passa igualmente ao lado desta tecnologia, na medida que esta requer uma menor utilização de plástico e de outros recursos prejudiciais ao meio ambiente.

NUEVA TECNOLOGÍA

Colección Beyond por BRUMA

Innovación desde dentro, en una sola pieza.

En sintonía con los diseños de vanguardia que definen las soluciones de BRUMA, la **Colección Beyond** representa el clímax de la simbiosis entre diseño, tecnología y eficiencia.

Fruto de su carácter tecnológicamente diferenciador, la serie **Beyond Collection** permite un proceso de instalación muy intuitivo, seguro y preciso. Dada su composición compacta y universal y la inclusión de elementos que facilitan el montaje (el nivel de burbuja, espacio para los tornillos en su marco de plástico e indicadores de ubicación de agua fría y caliente).

Además, el elemento incorporado permite reducir en cerca de un 20% el número de pasos necesarios para su instalación, con el consiguiente recorte de costes asociados.

La sostenibilidad también es una piedra que esta tecnología no deja sin remover, ya que exige un menor uso de plástico y otros materiales dañinos para el medio ambiente.



1

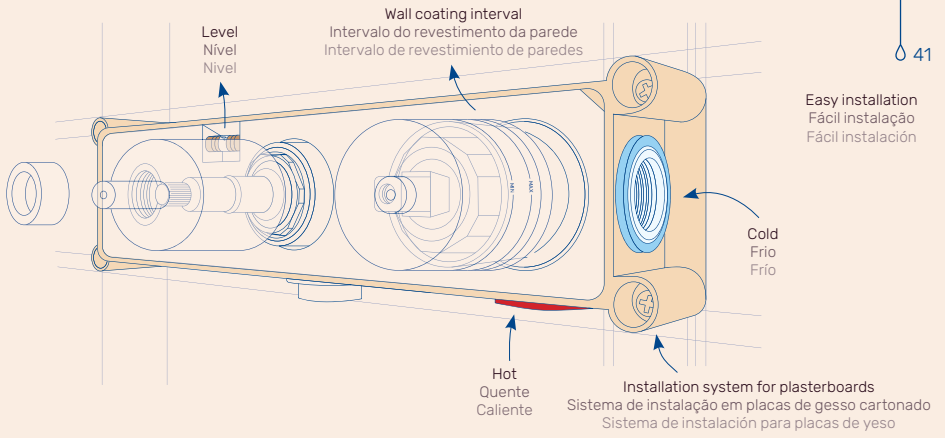

2

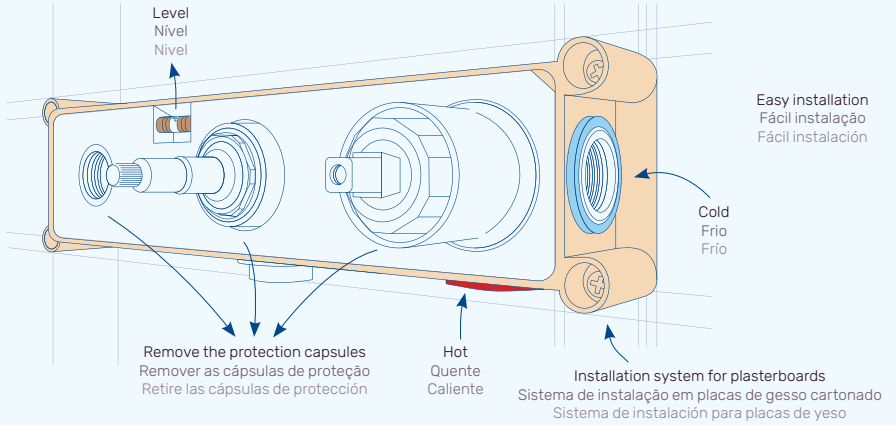

3

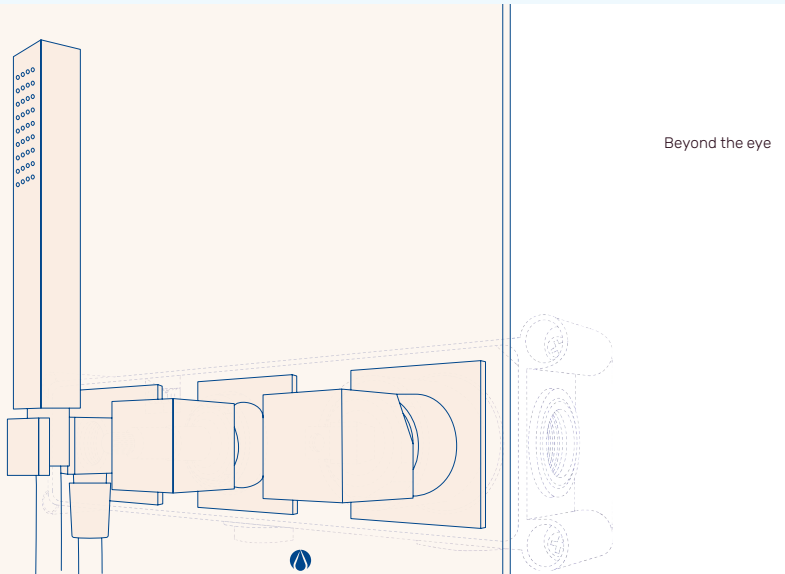

BRUMA

Technologies Tecnologias Tecnologías

BRUMA Brightest

BRUMA's chromium plating process results in an **intense, long-lasting and resistant finish** that stems from the brand's continuous investment in advanced technology equipment, which enables the development of exquisite products that stand the test of time.

O processo de cromagem da BRUMA resulta num **acabamento de brilho intenso, duradouro e resistente** fruto do investimento contínuo em equipamentos de avançada tecnologia que permitem desenvolver produtos de beleza duradoura.

El proceso de cromado de BRUMA da como resultado un **acabado intenso, duradero y resistente** que se deriva de la continua inversión de la marca en equipos de tecnología avanzada, lo que permite desarrollar productos exquisitos que resisten el paso del tiempo.

BRUMA EcoDrop

This technology uses a **mixture of air and water to offer the same immersive experience of comfort provided by a large flow**, while using less water.

Esta tecnologia recorre a uma mistura de ar e água para oferecer a mesma experiência

envolvente de conforto proporcionada por um grande fluxo, utilizando, no entanto, uma menor quantidade de água.

Esta tecnología utiliza una mezcla de aire y agua para ofrecer la misma experiencia inmersiva de comodidad proporcionada por un gran flujo, mientras usa menos agua.

BRUMA Cold Start

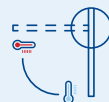

The option for BRUMA Smooth Breeze cartridges with Cold Start technology **allows you to save water and energy in your daily practices, without losing control of temperature and water flow.**

A opção por cartuchos BRUMA Smooth Breeze com tecnologia Cold Start permite **poupar água e energia nas suas práticas diárias, sem perder o controlo de temperatura e caudal da água.**

La opción por cartuchos BRUMA Smooth Breeze con tecnología Cold Start le **permite ahorrar agua y energía en sus prácticas diarias, sin perder el control de la temperatura y el caudal de agua.**



BRUMA Smooth Breeze



The exclusive **BRUMA Smooth Breeze** cartridge consists of high-quality ceramic discs, which provide a unique sensation of smoothness and precision in controlling the water flow and regulating temperature.

O cartucho exclusivo **BRUMA Smooth Breeze** é constituído por discos cerâmicos de alta qualidade, que proporcionam uma sensação única de suavidade e precisão no controlo do fluxo de água e regulação da temperatura.

El cartucho exclusivo **BRUMA Smooth Breeze** está formado por discos cerâmicos de alta calidad, que proporcionan una sensación única de suavidad y precisión en el control del caudal de agua y la regulación de la temperatura.

BRUMA Air EcoDrop

The **BRUMA Air EcoDrop** system transforms a routine shower into a sensory experience of therapeutic properties. Developed with the aim of improving the sensation of well-being and **efficiency in water** management, this system **provides a more intense and dynamic output of water, allowing an average water saving of 30% simultaneously.**

O sistema **BRUMA Air EcoDrop** transforma um duche rotineiro numa experiência

sensorial com qualidades terapêuticas. Desenvolvido com o intuito de melhorar a sensação de bem-estar e de **eficiência na gestão da água**, este sistema proporciona uma saída de água **mais intensa e dinâmica, possibilitando uma poupança média de água de 30% em simultâneo.**

El sistema **BRUMA Air EcoDrop** transforma una ducha rutinaria en una experiencia sensorial de propiedades terapéuticas. Desarrollada con el objetivo de mejorar la sensación de bienestar y la **eficiencia en la gestión del agua**, este sistema proporciona una **salida de agua más intensa y dinámica, permitiendo un ahorro medio de agua del 30% simultáneamente.**

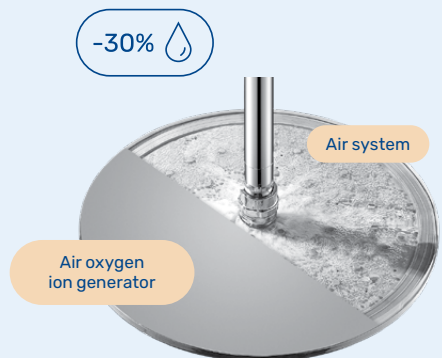



bruma.pt

