



KNAUFCEILING
Solutions

DATA SHEET

HERADESIGN[®] Corridor











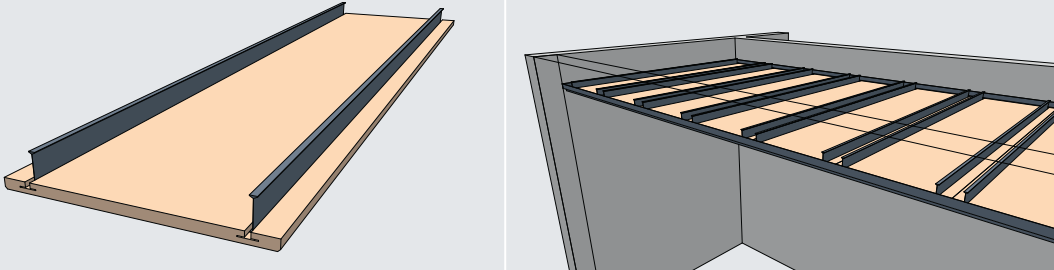
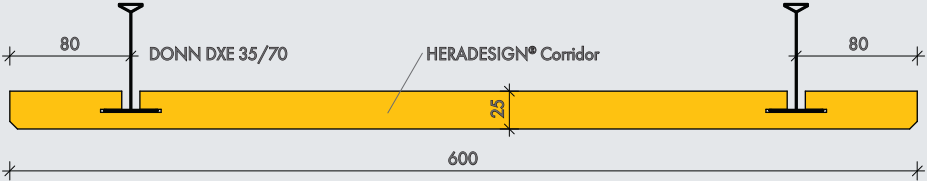
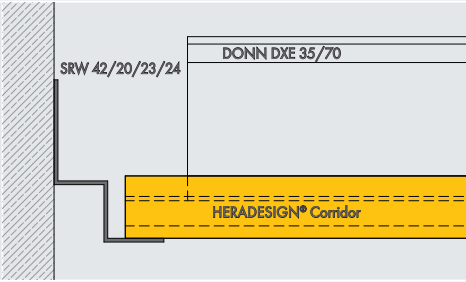

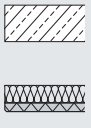

























- Free-span system complete with all necessary components
- Concealed installation with no visible grid
- No hangers required
- Simple and quick installation
- Each panel is independently demountable for easy access to the void
- Panels can be made in specific lengths to suit the corridor width
- Available in the full HERADESIGN[®] range of colours
- Available in both A2-s 1,d0 and B-s 1,d0 2 fire classes

KNAUFCEILINGSOLUTIONS.COM

YOUR **CEILING**
OUR **SOLUTIONS**

DATA SHEET
HERADESIGN® Corridor
PRODUCT DATA

<p>Product description</p>	<ul style="list-style-type: none"> Ceiling element with a width of 600mm and a maximum length of 2400mm for free-span lay-in installation on perimeter angle. The element consists of a 25mm thick HERADESIGN wood wool tile with two milled grooves on the reverse-side of the long sides. The supporting profiles (DONN DXE 35/70), included in the delivery, are pushed into the grooves on both sides on site. The perimeter profile for this system is a perimeter shadow angle (SRW 42/20/23/24) with a material thickness of 1.5mm.  																																																																				
<p>Technical data</p>	<table border="1"> <thead> <tr> <th>Product</th> <th>Length [mm]</th> <th>Width [mm]</th> <th>Thickness [mm]</th> <th>Weight [kg/m²]</th> </tr> </thead> <tbody> <tr> <td>HERADESIGN® Corridor Superfine</td> <td>max. 2400</td> <td>600</td> <td>25</td> <td>12,60</td> </tr> <tr> <td>HERADESIGN® Corridor Fine</td> <td>max. 2400</td> <td>600</td> <td>25</td> <td>13,30</td> </tr> <tr> <td>HERADESIGN® Corridor Superfine A2</td> <td>max. 2100</td> <td>600</td> <td>25</td> <td>18,00</td> </tr> <tr> <td>HERADESIGN® Corridor Fine A2</td> <td>max. 2100</td> <td>600</td> <td>25</td> <td>19,00</td> </tr> </tbody> </table> 	Product	Length [mm]	Width [mm]	Thickness [mm]	Weight [kg/m ²]	HERADESIGN® Corridor Superfine	max. 2400	600	25	12,60	HERADESIGN® Corridor Fine	max. 2400	600	25	13,30	HERADESIGN® Corridor Superfine A2	max. 2100	600	25	18,00	HERADESIGN® Corridor Fine A2	max. 2100	600	25	19,00																																											
Product	Length [mm]	Width [mm]	Thickness [mm]	Weight [kg/m ²]																																																																	
HERADESIGN® Corridor Superfine	max. 2400	600	25	12,60																																																																	
HERADESIGN® Corridor Fine	max. 2400	600	25	13,30																																																																	
HERADESIGN® Corridor Superfine A2	max. 2100	600	25	18,00																																																																	
HERADESIGN® Corridor Fine A2	max. 2100	600	25	19,00																																																																	
<p>Sound absorption</p>	<table border="1"> <thead> <tr> <th rowspan="2">Surface</th> <th rowspan="2">Thickness [mm]</th> <th rowspan="2">TCH* [mm]</th> <th colspan="7">Frequency [Hz], α_p</th> <th rowspan="2">Entire range</th> <th rowspan="2">Class</th> </tr> <tr> <th>125</th> <th>250</th> <th>500</th> <th>1000</th> <th>2000</th> <th>4000</th> <th>NRC</th> <th>α_w</th> </tr> </thead> <tbody> <tr> <td>HERADESIGN® Corridor Superfine</td> <td>25</td> <td>200</td> <td>0,35</td> <td>0,65</td> <td>0,70</td> <td>0,55</td> <td>0,65</td> <td>0,90</td> <td>0,60</td> <td>0,65 (H)</td> <td>C</td> </tr> <tr> <td>HERADESIGN® Corridor Fine</td> <td>25</td> <td>200</td> <td>0,40</td> <td>0,75</td> <td>0,65</td> <td>0,55</td> <td>0,75</td> <td>0,85</td> <td>0,70</td> <td>0,65 (LH)</td> <td>C</td> </tr> <tr> <td>HERADESIGN® Corridor Superfine A2</td> <td>25</td> <td>200</td> <td>0,35</td> <td>0,70</td> <td>0,70</td> <td>0,50</td> <td>0,65</td> <td>0,90</td> <td>0,65</td> <td>0,60 (LH)</td> <td>C</td> </tr> <tr> <td>HERADESIGN® Corridor Fine A2</td> <td>25</td> <td>200</td> <td>0,45</td> <td>0,80</td> <td>0,65</td> <td>0,50</td> <td>0,65</td> <td>0,90</td> <td>0,65</td> <td>0,60 (LH)</td> <td>C</td> </tr> </tbody> </table> <p>* Total Construction Height</p>  	Surface	Thickness [mm]	TCH* [mm]	Frequency [Hz], α_p							Entire range	Class	125	250	500	1000	2000	4000	NRC	α_w	HERADESIGN® Corridor Superfine	25	200	0,35	0,65	0,70	0,55	0,65	0,90	0,60	0,65 (H)	C	HERADESIGN® Corridor Fine	25	200	0,40	0,75	0,65	0,55	0,75	0,85	0,70	0,65 (LH)	C	HERADESIGN® Corridor Superfine A2	25	200	0,35	0,70	0,70	0,50	0,65	0,90	0,65	0,60 (LH)	C	HERADESIGN® Corridor Fine A2	25	200	0,45	0,80	0,65	0,50	0,65	0,90	0,65	0,60 (LH)	C
Surface	Thickness [mm]				TCH* [mm]	Frequency [Hz], α_p								Entire range	Class																																																						
		125	250	500		1000	2000	4000	NRC	α_w																																																											
HERADESIGN® Corridor Superfine	25	200	0,35	0,65	0,70	0,55	0,65	0,90	0,60	0,65 (H)	C																																																										
HERADESIGN® Corridor Fine	25	200	0,40	0,75	0,65	0,55	0,75	0,85	0,70	0,65 (LH)	C																																																										
HERADESIGN® Corridor Superfine A2	25	200	0,35	0,70	0,70	0,50	0,65	0,90	0,65	0,60 (LH)	C																																																										
HERADESIGN® Corridor Fine A2	25	200	0,45	0,80	0,65	0,50	0,65	0,90	0,65	0,60 (LH)	C																																																										
<p>Packaging units</p>	<p>Panels stacked on pallets. Support profiles and perimeter trims are bundled separately on a pallet.</p>																																																																				
<p>Humidity resistance</p>	<p>Not suitable for outdoor application, indoor swimming pool or spa areas.</p>																																																																				
<p>Cleanability</p>	 																																																																				
<p>Sustainability</p>																																																																					
<p>Colours</p>	<table border="1"> <thead> <tr> <th colspan="2">Standard colours</th> <th colspan="7">Vario Design colours</th> </tr> </thead> <tbody> <tr> <td></td> <td></td> <td></td> <td></td> <td></td> <td></td> <td></td> <td></td> <td></td> <td></td> </tr> <tr> <td>White Similar to RAL 9010</td> <td>Beige Natural tone 13</td> <td>Granite</td> <td>Steel</td> <td>Green Marble</td> <td>Copper</td> <td>Oak</td> <td>Brass</td> <td>Sandstone</td> <td>Concrete</td> </tr> </tbody> </table> <ul style="list-style-type: none"> Other colours from popular RAL and NCS colour systems are available. Deviations in colour and visual appearance may occur due to the rough fibre and panel surface. 	Standard colours		Vario Design colours																	White Similar to RAL 9010	Beige Natural tone 13	Granite	Steel	Green Marble	Copper	Oak	Brass	Sandstone	Concrete																																							
Standard colours		Vario Design colours																																																																			
																																																																					
White Similar to RAL 9010	Beige Natural tone 13	Granite	Steel	Green Marble	Copper	Oak	Brass	Sandstone	Concrete																																																												

DATA SHEET
HERADESIGN® Corridor
INSTALLATION

1.

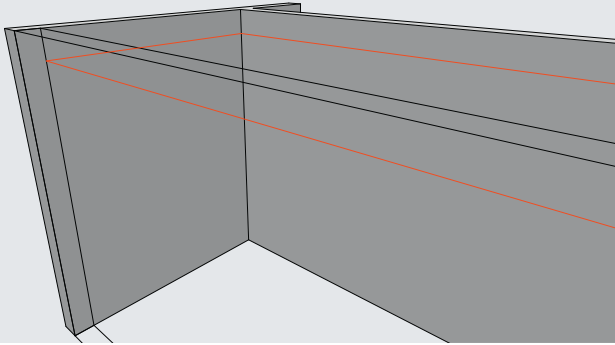

Mark the height on all perimeter walls (upper edge of the perimeter angle).

2.

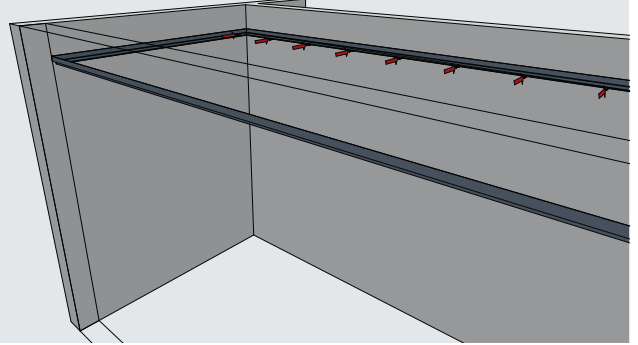

Install the perimeter angle using approved plugs and screws. Maximum spacing of the fixings 400mm. The perimeter angle should be mitred at the corners.

3.

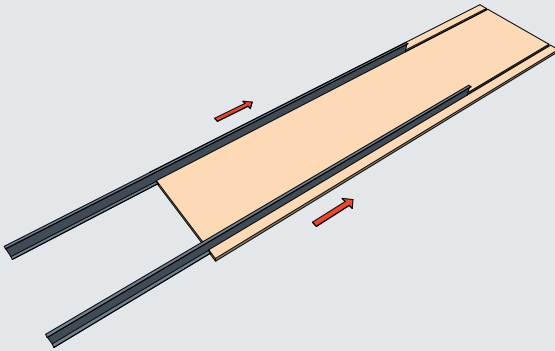

Push the T-profiles into the grooves on the reverse side of the HERADESIGN® Corridor panel. Centre the profiles. Tile overhang 25mm right and left.

4.

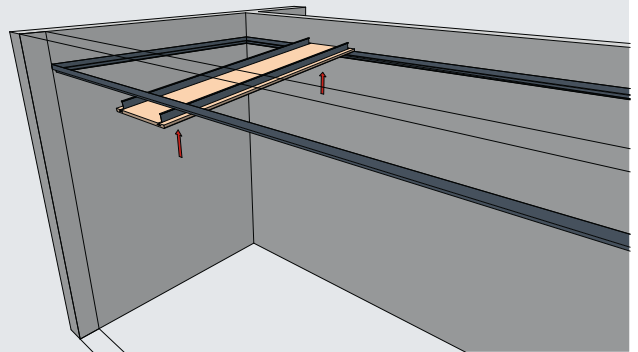

Insert the first tile at the beginning or end of the corridor.

5.

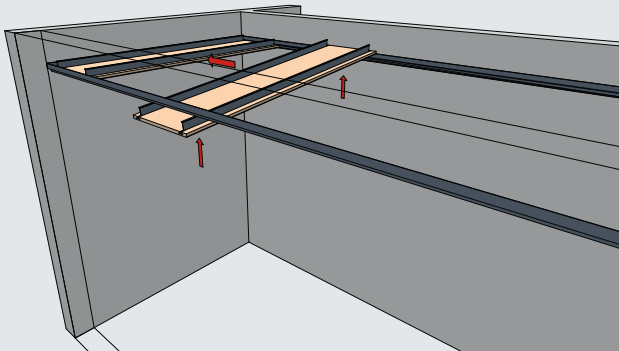

Continue to insert further HERADESIGN® Corridor elements.

6.

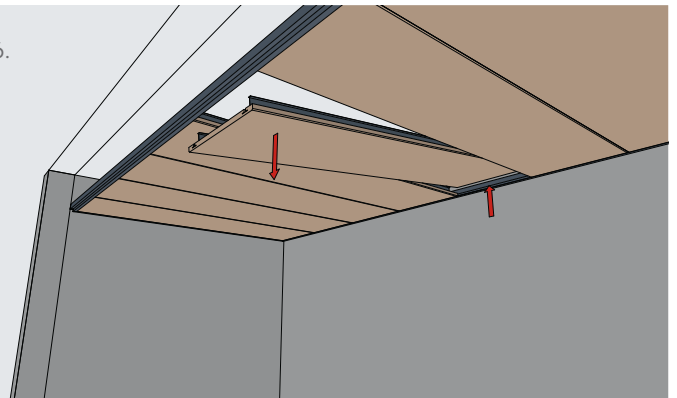

HERADESIGN® Corridor elements are demountable by gently lifting the tile up and moving to the side.

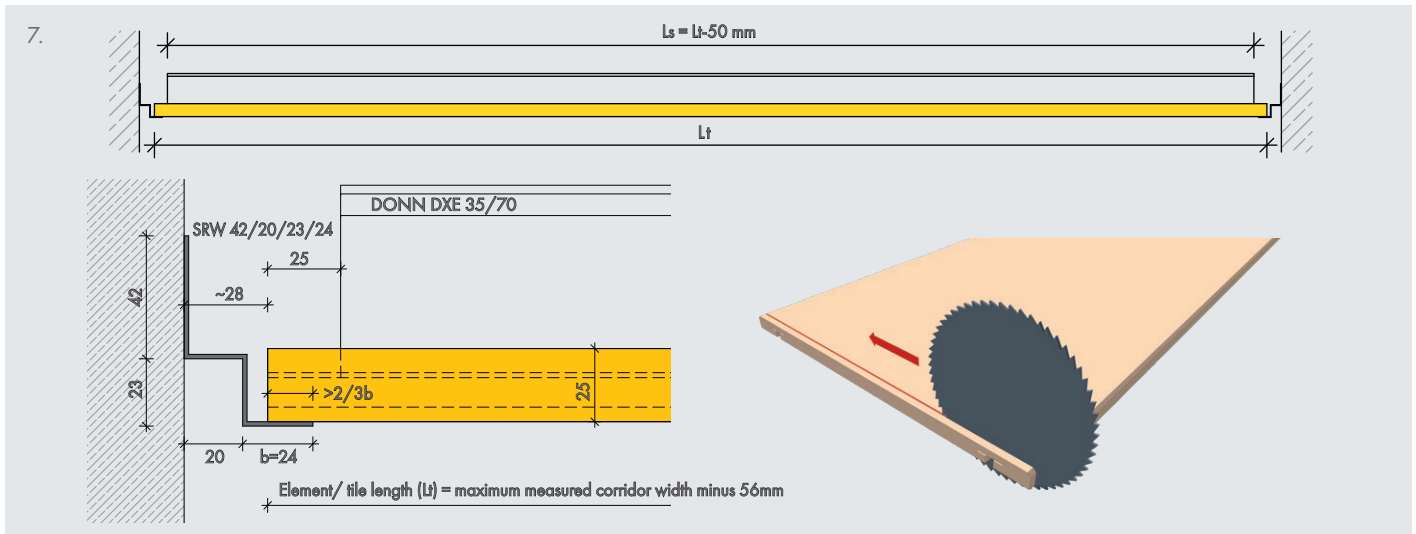

HERADESIGN® Corridor is available to order in every required length up to a maximum tile length (L_t) of 2400mm. To allow for structural tolerances, the main profiles are 25mm shorter than the tile, at both ends. The elements can be shortened by up to 50mm when required. This can be carried out with a hand saw, circular saw or with a table saw.

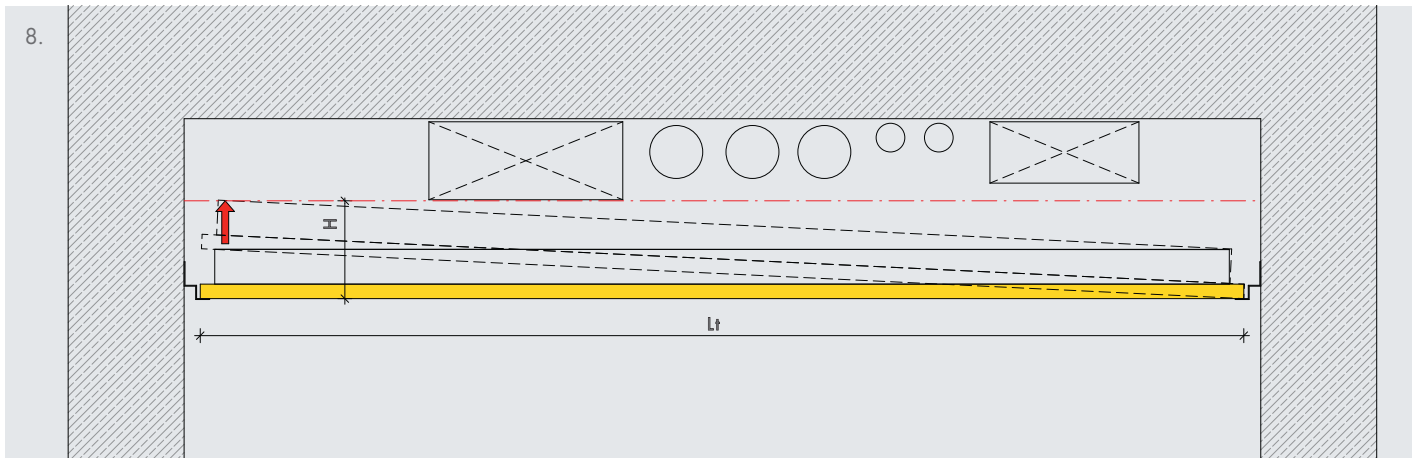

HERADESIGN® Corridor can be installed or demounted by gently lifting the tile and moving it to the side. The minimum installation height (H) is 150mm.

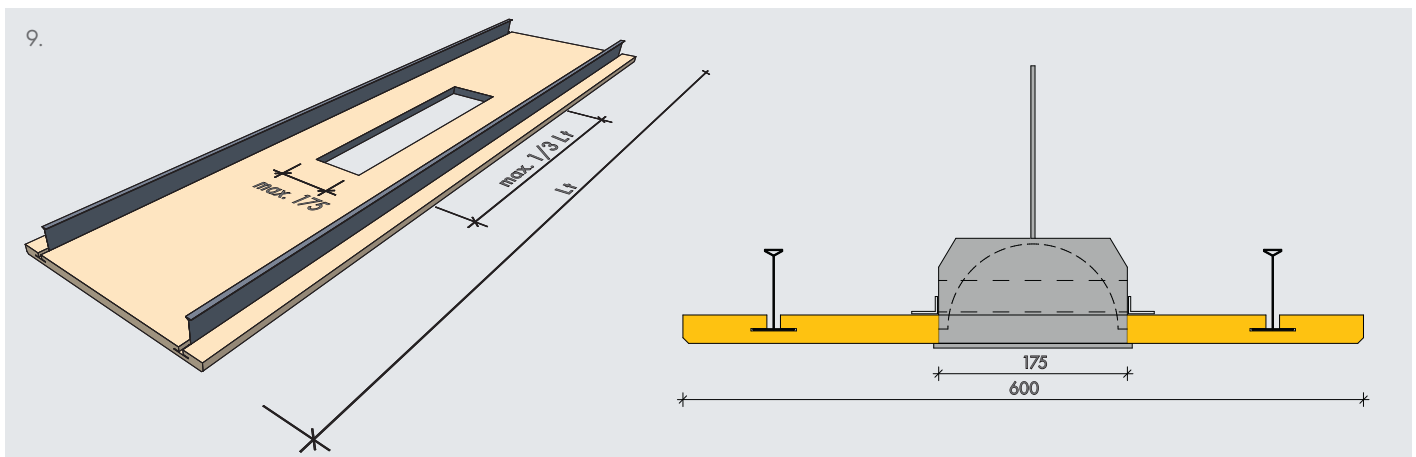

Additional loads $>1.5 \text{ kg}$ should be fixed to the soffit with independent hangers. For installations such as recessed lighting, loudspeakers etc., the maximum width of the cut-out opening is 175mm. The maximum length of the cut-out opening is one third of the tile length ($=1/3 L_t$).

Products may vary from country to country. Please contact your local sales representative. For further information and legal notice, please visit our website.